

Datenblatt:

965+0119+004

TSS-Faltarm III XL (900)

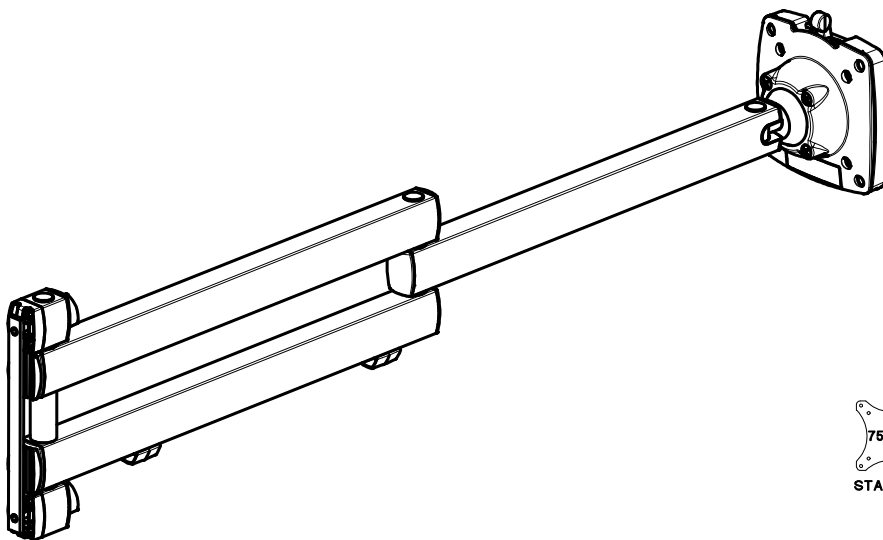
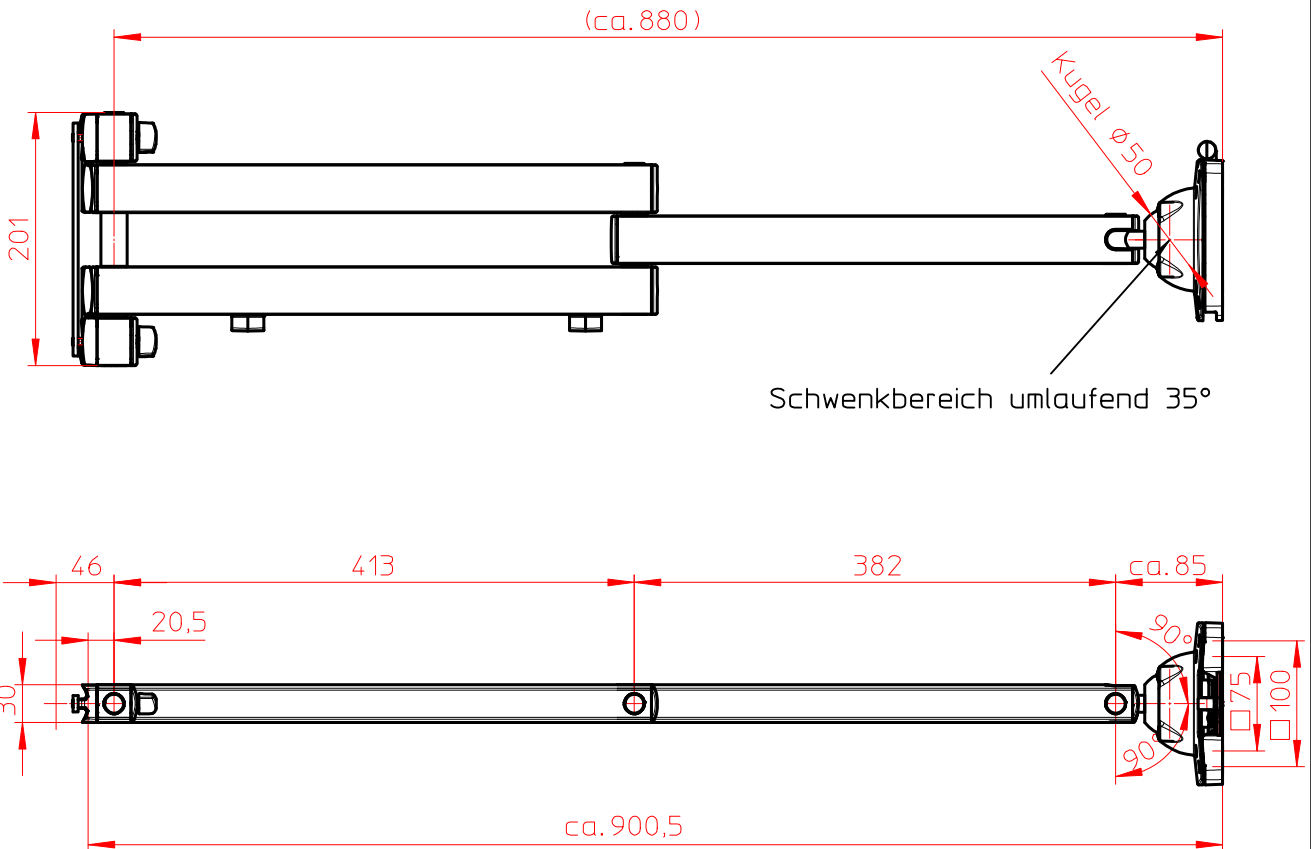

Technische und Design Änderungen vorbehalten!
Technical and design modifications reserved! 06.01.11