

# viewmate <sup>x</sup>

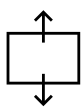

600 mm (23,6")

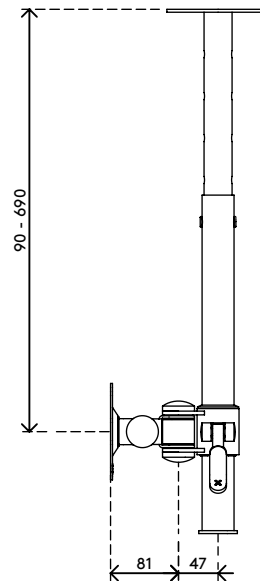
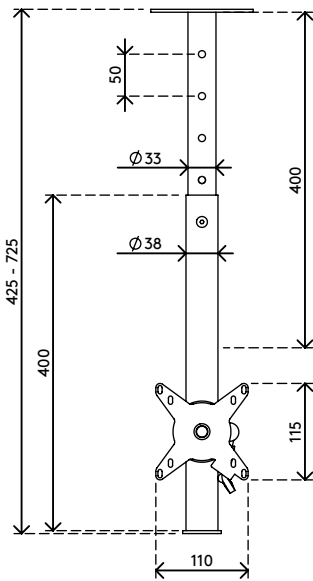
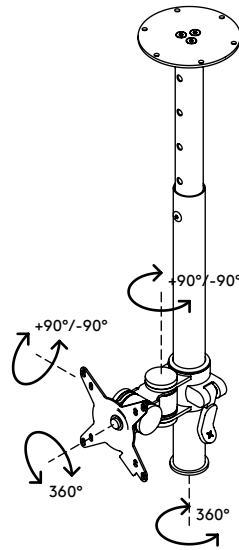
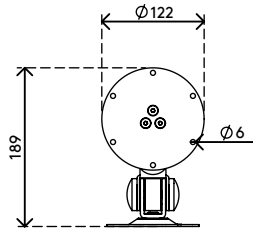

+90°/-90°

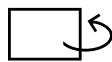

+90°/-90°



360°



1104 mm (43,5")



75 x 75/100 x 100



15 kg

## Viewmate Monitorarm - Decke 562

2019/06/24

# 52.562

 440 x 170 x 135 mm

 1 pcs

 silber

 2,9 kg

 805410525620