

viewlite

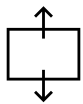

240 mm (9,4")

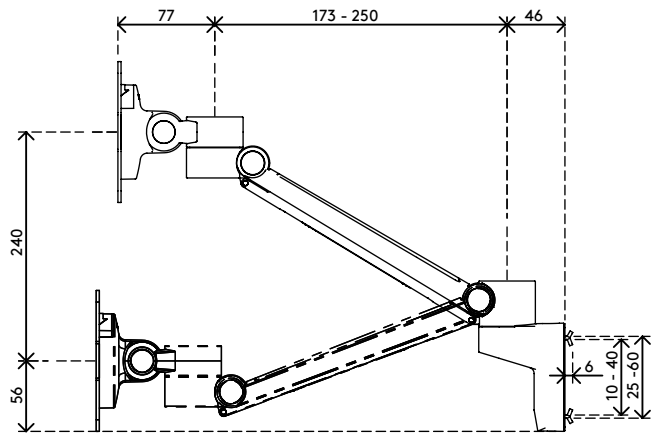
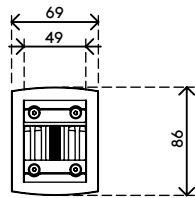
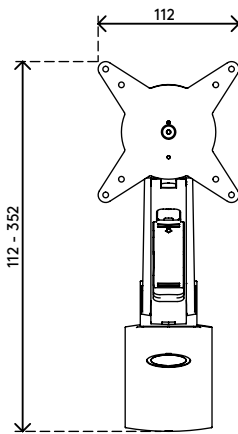
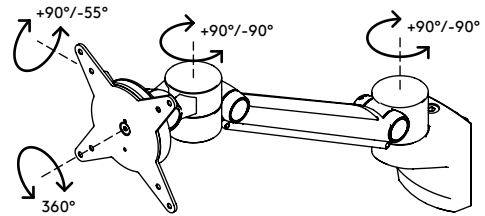
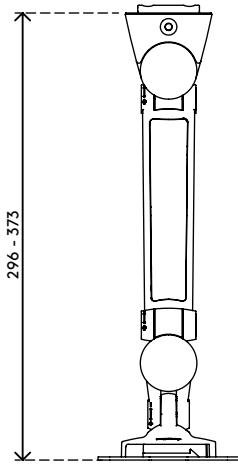

+90°/-55°



+90°/-90°



360°



75 x 75/100 x 100



0 - 7 kg

Viewlite plus Monitorarm - Schiene 512

2019/06/24

58.512

 477 x 153 x 145 mm

 1 pcs

 silber-Weiß

 2,151 kg

 805410585129