

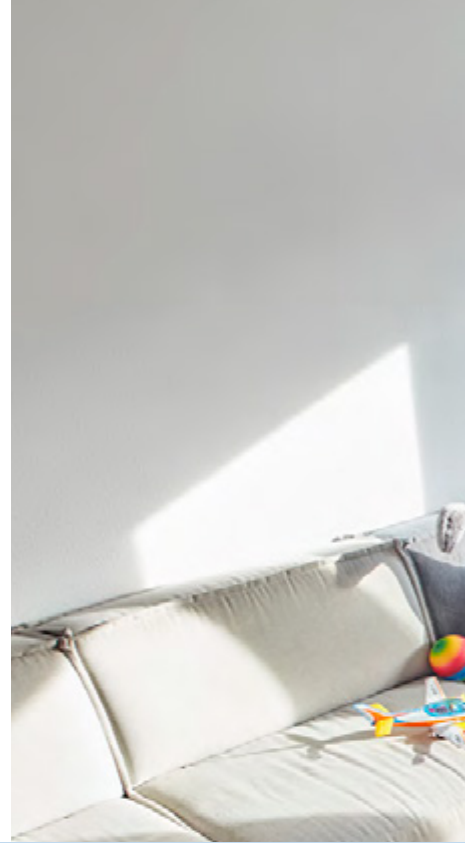

# COMFORT Series TV wall mounts

Every TV stylishly and secure on the wall, just how your customer wants it



# New TV wall mount product line

Vogel's gives the market for TV wall mounts a fresh impulse with the introduction of a new product line: COMFORT.

The products are optimally tailored to today's market with larger screens of up to 100 inches! The support arms have been lengthened, for example, and the load capacity has also been considerably increased. In addition, the packaging is 'eco friendly', in line with the sustainability ambitions of Vogel's.

With the COMFORT Series, we are serving the middle segment of the market, with families in mind. It's designed to last, staying strong after years of use. It's built for safety. And it's built for style.

With the introduction of series in various price segments we are making it easier for the consumer to make the right choice. The attractive product design, the safe functions and the new packaging design all contribute to this.



**SECURE**  
SOLUTION

# COMFORT Series

## **COMFORT: Stylish & secure**

The COMFORT Series is designed for families with children in mind. A consumer group that uses the TV intensively. That is why COMFORT wall mounts have a stylish design that puts safety first. COMFORT wall mounts are suitable for TVs from 19 to 100 inches and weighing up to 75 kg.

The Full-Motion products have long arms and are equipped with the TiltAnchor™ system (EU patent pending) for a secured home position of the TV. These versions also feature OneFinger™ Movement. Thanks to the PTFE-coated bearings, you can effortlessly move the TV to the desired position with just one finger. And in combination with the extra-reinforced steel bearings, this will remain the case for many years.

In addition, as an OLED TV wall mount specialist, Vogel's is launching an OLED version. It connects seamlessly to the back of the OLED TV, so that the minimalistic design is preserved. Because OLED TVs are fragile, the tilt function can easily be blocked.

The Fixed and Tilt versions in this series feature the unique ClickLoc™ (EU patent pending) safety system. This system lets the consumer know with an audible click that the TV is securely fastened. Fixed models are equipped with a maintenance setting, allowing easy access to the cables even after mounting on the wall.



## Important advantages of the COMFORT Series

- For everyday use: Designed with family in mind
- Built to last : Stays strong after years of use
- Mounting made easy with our free DrillRight™ Augmented Reality app
- Drilling template, bolts, plugs and spirit level included
- 10 years guarantee

# COMFORT series features

Tilt  
&  
Fixed

- Lock your TV with a single click - Easily secure or release your TV through ClickLoc™ (EU patent pending)
- Framed like a painting - Neat, clean TV mounting, just 2.2 cm from the wall
- Effortless tilting - Avoid reflections and tilt up to 20°
- Perfectly level installation - Spirit level included
- Protective TV patches - Protect the rear of your TV with soft protective patches
- Easy cable access



Lock your TV  
with a single click

**ClickLoc™**  
SAFETY SYSTEM



Framed like  
a painting



Perfectly level  
installation



Effortless tilting



Move your TV smoothly



Easily lock & release with TiltAnchor

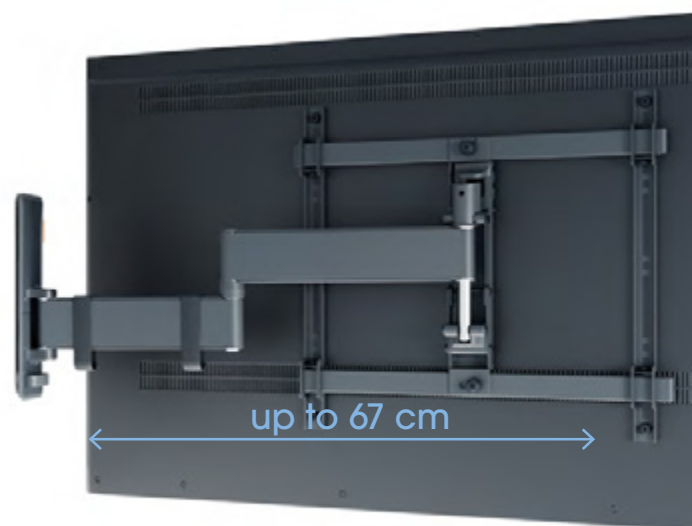

Turn your TV up to 180°

## Full-Motion

- Smooth OneFinger™ Movement - Thanks to coated bearings and precision steel shafts
- Perfectly level installation - Free spirit level included
- Keep your TV always level - Easy after installation levelling (horizontally and vertically)
- Protective TV patches - Protect the rear of your TV with soft protective patches
- Turn your TV up to 180° - Long arms of 49 (S) | 58 (M) | 67 (L) cm help you position your TV easily
- Easily lock and release with TiltAnchor™ - Keep your valuable TV securely in place (EU patent pending) (M & L)
- Cable strips included - keep your cables neat and safe



## Wooden floor stand

The COMFORT range also includes a stylish, oak floor stand with an anthracite-coloured epoxy-lacquered steel base. The floor stand is suitable for TVs with screen sizes of 44 to 77 inches and a weight of up to 50 kg.

What immediately stands out about the floor stand is its slim, timeless design. The upright section is made of sustainably produced, varnished oak wood. In addition, the screen can be rotated and adjusted in height. The floor stand is very stable. So you can be absolutely sure that your TV will hang safely. This makes the floor stand not only user-friendly, but also suitable for families with children.





The consumer can get started immediately after purchase. A drilling template, screws and fischer® DuoPower plugs are included in the packaging as standard. For added ease of installation, there is also the free DrillRight™ Augmented Reality App.

Moreover, COMFORT wall mounts are designed to last. Even after years of intensive use, they remain just as strong, safe and stylish. This means that we can offer consumers a 10-year guarantee on all wall mounts in the COMFORT Series.

## Useful accessories

### **To neatly hide cables and media boxes**

With a new product line of TV wall mounts comes a new range of accessories. As a retailer, you get additional sales from the category and maximise your 'attach sales'. Vogel's has chosen a range of accessories that stand for ease of use and smart installation.

Most people prefer to hide cables and media boxes out of view. Vogel's offers

a number of handy solutions for this.

Our cable covers, cable straps and cable sleeves enable you to hide cables neatly. Or you can use the accessories from our cable management kit.

The media box holder is ideal for installing a media box safely and invisibly behind the TV.

All accessories have the added value your customer seeks.

**NEW**  
**TVM 3660 Series**  
Full-Motion+ TV Wall Mount

**NEW**  
**TVM 3460 Series**  
Full-Motion+ TV Wall Mount



FULL-MOTION+

Name TVM 3665 Full-Motion TV Wall Mount

**Specifications**

Min. / Max. TV screen size (inch)	40 / 77	32 / 65
Max. weight load (kg)	35	25
Max. VESA hole pattern (mm)	600 x 400	400 x 400
Number of pivot points	3	3
Turn	Up to 180°	Up to 180°
Tilt	Tilt up to 20°	Tilt up to 20°
Min. / Max. distance to the wall (mm)	59 / 670	59 / 580
Cable management	Cable clips	Cable clips
Spirit level included	•	•

**Guarantee**

TÜV certified		
Guarantee	10 years	10 years

**General**

Name	TVM 3665 Full-Motion TV Wall Mount	
Colour	Black	Black
Article number	3836650	3834670
EAN single box	8712285351860	

What's in the box

- |  |  |
|--|--|
| <ul style="list-style-type: none"> <li>• Wall mount</li> <li>• Cable clips</li> <li>• Wall mounting kit with fischer® Duo Power plugs</li> <li>• TV fasteners kit</li> <li>• Protective TV patches</li> <li>• Spirit level</li> <li>• Quick Installation Guide</li> <li>• DrillRight™ AR app</li> <li>• Drilling template</li> </ul> | <ul style="list-style-type: none"> <li>• Wall mount</li> <li>• Cable clips</li> <li>• Wall mounting kit with fischer® Duo Power plugs</li> <li>• TV fasteners kit</li> <li>• Protective TV patches</li> <li>• Spirit level</li> <li>• Quick Installation Guide</li> <li>• DrillRight™ AR app</li> <li>• Drilling template</li> </ul> |
|--|--|

Number in outer box (#)	3	4
-------------------------	---	---



## FULL-MOTION+

**NEW**

### TVM 3640 Series

Full-Motion+ TV Wall Mount



**NEW**

### TVM 3440 Series

Full-Motion+ TV Wall Mount





**NEW**

### TVM 3240 Series

Full-Motion+ TV Wall Mount



Name	TVM 3645 Full-Motion TV Wall Mount (white) TVM 3645 Full-Motion TV Wall Mount (black)	TVM 3445 Full-Motion TV Wall Mount (white) TVM 3445 Full-Motion TV Wall Mount (black)	TVM 3245 Full-Motion TV Wall Mount (white) TVM 3245 Full-Motion TV Wall Mount (black)
<b>Specifications</b>			
Min. / Max. TV screen size (inch)	40 / 77	32 / 65	19 / 43
Max. weight load (kg)	35	25	15
Max. VESA hole pattern (mm)	600 x 400	400 x 400	200 x 200
Number of pivot points	3	3	3
Turn	Up to 180°	Up to 180°	Up to 180°
Tilt	Tilt up to 20°	Tilt up to 20°	Tilt up to 20°
Min. / Max. distance to the wall (mm)	59 / 670	59 / 580	65 / 493
Cable management	Cable clips	Cable clips	Cable clips
Spirit level included	•	•	•
<b>Guarantee</b>			
TÜV certified			
Guarantee	10 years	10 years	10 years
<b>General</b>			
Name	TVM 3645 Full-Motion TV Wall Mount (white) TVM 3645 Full-Motion TV Wall Mount (black)	TVM 3445 Full-Motion TV Wall Mount (white) TVM 3445 Full-Motion TV Wall Mount (black)	TVM 3245 Full-Motion TV Wall Mount (white) TVM 3245 Full-Motion TV Wall Mount (black)
Colour	Black   White	Black   White	Black   White
Article number	3836450 (Black) 3836451 (White)	3834450 (Black) 3834451 (White)	3832450 (Black) 3832451 (White)
EAN single box	8712285347887 (Black) 8712285347900 (White)	8712285347788 (Black) 8712285347801 (White)	8712285347689 (Black) 8712285347702 (White)
What's in the box	<ul style="list-style-type: none"> <li>• Wall mount</li> <li>• Cable clips</li> <li>• Wall mounting kit with fischer® Duo Power plugs</li> <li>• TV fasteners kit</li> <li>• Protective TV patches</li> <li>• Spirit level</li> <li>• Quick Installation Guide</li> <li>• DrillRight™ AR app</li> <li>• Drilling template</li> </ul>	<ul style="list-style-type: none"> <li>• Wall mount</li> <li>• Cable clips</li> <li>• Wall mounting kit with fischer® Duo Power plugs</li> <li>• TV fasteners kit</li> <li>• Protective TV patches</li> <li>• Spirit level</li> <li>• Quick Installation Guide</li> <li>• DrillRight™ AR app</li> <li>• Drilling template</li> </ul>	<ul style="list-style-type: none"> <li>• Wall mount</li> <li>• Cable clips</li> <li>• Wall mounting kit with fischer® Duo Power plugs</li> <li>• TV fasteners kit</li> <li>• Protective TV patches</li> <li>• Spirit level</li> <li>• Quick Installation Guide</li> <li>• DrillRight™ AR app</li> <li>• Drilling template</li> </ul>
Number in outer box (#)	3	4	4



**NEW**

## TVM 3620 Series

Full-Motion TV Wall Mount

**NEW**

## TVM 3420 Series

Full-Motion TV Wall Mount

**NEW**

## TVM 3220 Series

Full-Motion TV Wall Mount

## FULL-MOTION



Name	TVM 3625 Full-Motion TV Wall Mount	TVM 3425 Full-Motion TV Wall Mount	TVM 3225 Full-Motion TV Wall Mount
------	------------------------------------	------------------------------------	------------------------------------

### Specifications

Min. / Max. TV screen size (inch)	40 / 77	32 / 65	19 / 43
Max. weight load (kg)	35	25	15
Max. VESA hole pattern (mm)	600 x 400	400 x 400	200 x 200
Number of pivot points	2	2	2
Turn	Up to 120°	Up to 120°	Up to 120°
Tilt	Tilt up to 20°	Tilt up to 20°	Tilt up to 20°
Min. / Max. distance to the wall (mm)	50 / 388	50 / 343	58 / 302
Cable management	Cable clip	Cable clip	Cable clip
Spirit level included	•	•	•

### Guarantee

TÜV certified			
Guarantee	10 years	10 years	10 years

### General

Name	TVM 3625 Full-Motion TV Wall Mount	TVM 3425 Full-Motion TV Wall Mount	TVM 3225 Full-Motion TV Wall Mount
Colour	Black	Black	Black
Article number	3836250 (Black)	3834250 (Black)	3832250 (Black)
EAN single box	8712285347863 (Black)	8712285347764 (Black)	8712285347665 (Black)

### What's in the box

	<ul style="list-style-type: none"> <li>• Wall mount</li> <li>• Cable clip</li> <li>• Wall mounting kit with fischer® Duo Power plugs</li> <li>• TV fasteners kit</li> <li>• Protective TV patches</li> <li>• Spirit level</li> <li>• Quick Installation Guide</li> <li>• DrillRight™ AR app</li> <li>• Drilling template</li> </ul>	<ul style="list-style-type: none"> <li>• Wall mount</li> <li>• Cable clip</li> <li>• Wall mounting kit with fischer® Duo Power plugs</li> <li>• TV fasteners kit</li> <li>• Protective TV patches</li> <li>• Spirit level</li> <li>• Quick Installation Guide</li> <li>• DrillRight™ AR app</li> <li>• Drilling template</li> </ul>	<ul style="list-style-type: none"> <li>• Wall mount</li> <li>• Cable clip</li> <li>• Wall mounting kit with fischer® Duo Power plugs</li> <li>• TV fasteners kit</li> <li>• Protective TV patches</li> <li>• Spirit level</li> <li>• Quick Installation Guide</li> <li>• DrillRight™ AR app</li> <li>• Drilling template</li> </ul>
--	---	---	---

Number in outer box (#)	3	4	4
-------------------------	---	---	---

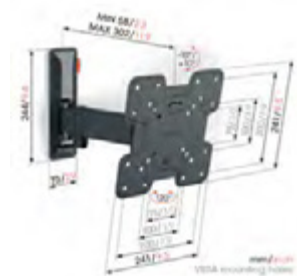

## TILT

**NEW**  
**TVM 3610 Series**  
Tilt TV Wall Mount

**NEW**  
**TVM 3410 Series**  
Tilt TV Wall Mount

**NEW**  
**TVM 3210 Series**  
Tilt TV Wall Mount



Name TVM 3615 Tilting TV Wall Mount TVM 3415 Tilting TV Wall Mount TVM 3215 Tilting TV Wall Mount

**Specifications**

Min. / Max. TV screen size (inch)	40 / 77	32 / 65	19 / 43
Max. weight load (kg)	35	25	15
Max. VESA hole pattern (mm)	600 x 400	400 x 400	200 x 200
Tilt	Tilt up to 20°	Tilt up to 20°	Tilt up to 20°
Min. distance to the wall (mm)	34	34	34
Spirit level included	•	•	•

**Guarantee**

TÜV certified			
Guarantee	10 years	10 years	10 years

**General**

Name	TVM 3615 Tilting TV Wall Mount	TVM 3415 Tilting TV Wall Mount	TVM 3215 Tilting TV Wall Mount
Colour	Black	Black	Black
Article number	3836150 (Black)	3834150 (Black)	3832150 (Black)
EAN single box	8712285347849 (Black)	8712285347740 (Black)	8712285347641 (Black)
What's in the box	<ul style="list-style-type: none"> <li>• Wall mount</li> <li>• Wall mounting kit with fischer® Duo Power plugs</li> <li>• TV fasteners kit</li> <li>• Protective TV patches</li> <li>• Spirit level</li> <li>• Quick Installation Guide</li> <li>• DrillRight™ AR app</li> <li>• Drilling template</li> </ul>	<ul style="list-style-type: none"> <li>• Wall mount</li> <li>• Wall mounting kit with fischer® Duo Power plugs</li> <li>• TV fasteners kit</li> <li>• Protective TV patches</li> <li>• Spirit level</li> <li>• Quick Installation Guide</li> <li>• DrillRight™ AR app</li> <li>• Drilling template</li> </ul>	<ul style="list-style-type: none"> <li>• Wall mount</li> <li>• Wall mounting kit with fischer® Duo Power plugs</li> <li>• TV fasteners kit</li> <li>• Protective TV patches</li> <li>• Spirit level</li> <li>• Quick Installation Guide</li> <li>• DrillRight™ AR app</li> <li>• Drilling template</li> </ul>
Number in outer box (#)	4	4	4





**NEW**  
**TVM 3600 Series**  
Fixed TV Wall Mount

**NEW**  
**TVM 3400 Series**  
Fixed TV Wall Mount

**NEW**  
**TVM 3200 Series**  
Fixed TV Wall Mount

## FIXED



Name	TVM 3605 Fixed TV Wall Mount	TVM 3405 Fixed TV Wall Mount	TVM 3205 Fixed TV Wall Mount
<b>Specifications</b>			
Min. / Max. TV screen sizes (inch)	40 / 100	32 / 77	19 / 50
Max. weight load (kg)	75	50	30
Max. VESA hole pattern (mm)	600 x 400	400 x 400	200 x 200
Min. distance to the wall (mm)	22	22	22
Spirit level included	•	•	•
<b>Guarantee</b>			
TÜV certified			
Guarantee	10 years	10 years	10 years
<b>General</b>			
Colour	Black	Black	Black
Name	TVM 3605 Fixed TV Wall Mount	TVM 3405 Fixed TV Wall Mount	TVM 3205 Fixed TV Wall Mount
Article number	3836050 (Black)	3834050 (Black)	3832050 (Black)
EAN single box	8712285347825 (Black)	8712285347726 (Black)	8712285347627 (Black)
What's in the box	<ul style="list-style-type: none"> <li>• Wall mount</li> <li>• Wall mounting kit with fischer® Duo Power plugs</li> <li>• TV fasteners kit</li> <li>• Protective TV patches</li> <li>• Spirit level</li> <li>• Quick Installation Guide</li> <li>• DrillRight™ AR app</li> <li>• Drilling template</li> </ul>	<ul style="list-style-type: none"> <li>• Wall mount</li> <li>• Wall mounting kit with fischer® Duo Power plugs</li> <li>• TV fasteners kit</li> <li>• Protective TV patches</li> <li>• Spirit level</li> <li>• Quick Installation Guide</li> <li>• DrillRight™ AR app</li> <li>• Drilling template</li> </ul>	<ul style="list-style-type: none"> <li>• Wall mount</li> <li>• Wall mounting kit with fischer® Duo Power plugs</li> <li>• TV fasteners kit</li> <li>• Protective TV patches</li> <li>• Spirit level</li> <li>• Quick Installation Guide</li> <li>• DrillRight™ AR app</li> <li>• Drilling template</li> </ul>
Number in outer box (#)	4	4	4



**NEW**  
**TVS 3690**  
TV Floor Stand



**NEW**  
**TVS 3695**  
TV Floor Stand



**Specifications**

Min. / Max. TV screen size (inch)	40 / 77	40 / 77
Max. weight load (kg)	50	50
Turn	Up to 90°	Up to 90°
Max. VESA hole pattern (mm)	600 x 400	600 x 400
Height (mm)	1100	1100
Width (mm)	842	842
Depth (mm)	554	554
Cable management	Integrated cable management	<ul style="list-style-type: none"> <li>Cable clips</li> <li>Integrated cable management</li> </ul>

**Guarantee**

TÜV certified		
Guarantee	10 years	10 years

**General**

Name	TVS 3690 TV Floor Stand (black)	TVS 3695 TV Floor Stand (black) TVS 3695 TV Floor Stand (white)
Colour	Steel (black)	Oak & Steel (black)   Oak & Steel (white)
Article number	3836900	3836950 (Oak & Steel (black)) 3836951 (Oak & Steel (white))
EAN single box	8712285355189	8712285353345 (Oak & Steel (black)) 8712285353369 (Oak & Steel (white))
What's in the box	<ul style="list-style-type: none"> <li>Floor stand</li> <li>Interface</li> <li>TV fasteners kit</li> <li>Protective TV patches</li> <li>Quick Installation Guide</li> <li>Allen key (8mm)</li> </ul>	<ul style="list-style-type: none"> <li>Floor stand</li> <li>Interface</li> <li>Cable clips</li> <li>TV fasteners kit</li> <li>Protective TV patches</li> <li>Quick Installation Guide</li> <li>Allen key (8mm)</li> </ul>



**NEW**  
**TVA 6000**  
Cable Cover



**NEW**  
**TVA 6202**  
Cable sleeve



**NEW**  
**TVA 6201**  
Cable Straps



**NEW**  
**TVA 6203**  
Cable management kit



## Specifications

	TVA 6000	TVA 6202	TVA 6201	TVA 6203
Set content	<ul style="list-style-type: none"> <li>No cable mess</li> <li>Cut to any length or direction</li> </ul>	<ul style="list-style-type: none"> <li>No cable mess</li> <li>Easy to open and auto close to wrap cables</li> <li>Expandable up to 4 cables (100 mm long, 18 mm diameter)</li> </ul>	<ul style="list-style-type: none"> <li>Strong, hook-and-loop design</li> <li>Includes: 6 straps of 300x20 mm</li> <li>Light weight, flexible and durable</li> </ul>	<ul style="list-style-type: none"> <li>12 tie-wraps (2 lengths)</li> <li>8 self-adhesive cable clips (2 sizes)</li> <li>8 cable hook and loop straps (2 sizes)</li> <li>6 self-adhesive cable tie mounting blocks (2 sizes)</li> <li>8 cable markers</li> </ul>
Max. number of cables to hold	Up to 4 cables	Up to 4 cables	Up to 10 cables	
Cable cover length (cm)	80 cm	100 cm		
Width (mm)	59	20	20	140
Depth (mm)	14			
<b>Guarantee</b>				
Guarantee	2 years	2 years	2 years	2 years
<b>General</b>				
Name	TVA 6000 Cable Cover (black) TVA 6000 Cable Cover (white)	TVA 6202 Cable sleeve	TVA 6201 Cable Straps	TVA 6203 Cable management kit
Article number	6860000 (Black) 6860001 (White)	6862020	6862010	6862030
EAN single box	8712285350429 (Black) 8712285350443 (White)	8712285350481	8712285350467	8712285350504
Number in outer box (#)	10	20	40	10





**NEW**

## TVA 6400

Media Box Mount



### Specifications

Set content

- Store your media box behind your TV
- Install it on your TV, mount or wall
- Suitable for almost all media boxes up to a maximum size of 190 x 130 x 45 mm

Max. weight load (kg)	1.5
Width (mm)	130
Depth (mm)	45
Length (mm)	190

### Guarantee

Guarantee	2 years
-----------	---------

### General

Name	TVA 6400 Media box mount
Article number	6864000
EAN single box	8712285350528
Number in outer box (#)	20



# For consumers, safety is the most important factor

## **New packaging design ensures greater distinctiveness on the shelf**

As the market leader, Vogel's stands for the security of making the best choice: For Sure. To make this proposition as visible as possible, Vogel's is introducing a new packaging design. This makes Vogel's stand out on the shelf.

An important message on the new packaging is "Safety First". Research shows that a lot of consumers consider safety to be the most important factor when buying a wall mount. Vogel's offers that security like no other. For example, the maximum tested weight load for our TV wall mounts is actually three times higher than stated. Because of this, our products are TÜV certified. We explain this briefly on the packaging.

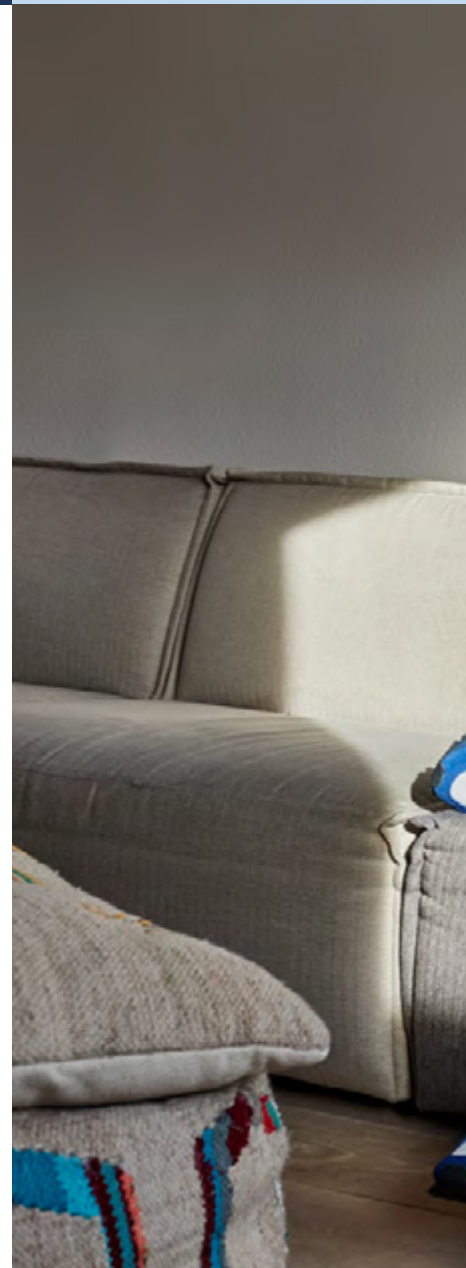

## Environmentally friendly packaging

Care for the environment is important to us at Vogel's. The new packaging has therefore been made as environmentally friendly as possible. The packaging no longer contains EPS (Expanded Polystyrene) parts. In addition, we have reduced the use of single-use plastics by 95%. Furthermore, it is good to know that both the products and the packaging are produced in accordance with the Business Social Compliance Initiative (BSCI).

**Vogel's. For Sure.**



# E-Partner Program™

As an e-tailer, you'd like to increase your conversion rate as efficiently as possible. That's why Vogel's offers the e-Partner Program™ (EPP), with lots of tools and resources to make it easier for you:

- Easily access rich content via Icecat, APIs or customised live feeds.
- Embed videos from Vogel's YouTube channel or use Flixmedia for up-to-date, inspiring and conversion-rate-enhancing product information, images and videos.
- Automatically display reviews in your webshop via the Bazaarvoice platform to boost your conversion rate and increase the prominence of your website.
- Integrate our Flatscreenfitter into your webshop, that consumers can easily find the right TV wall mount.
- Use our data on bundle sales to significantly increase your turnover.
- Make it easy on yourself by using our up-to-date content offer.

Would you like to know more about the E-Partner Program™? Do you need help implementing one of our tools? Or would you like tailored advice from our e-commerce team? Please contact us, we are happy to help!



# Maximise the wall mount category

With Vogel's TV wall mounts in your assortment you can get the most out of the categories. Vogel's makes it easier to sell the right mount with every TV sold and maximising your 'attach sales'.

In addition Vogel's offers a high quality product with the added value your customer seeks. This means you'll never have to deal with dissatisfied customers and you maximise the average cash value of the wall mount.

# Why Vogel's?

## What makes a Vogel's TV wall mount so special?

This is a question we are often asked. As the market leader in TV wall mounts and other AV equipment, we aim to reassure you that you are getting the best solution. Because when you are looking for an accessory, you don't just choose anything.

With Vogel's, you can offer customers the best-designed mounting solution for their valued TV. Our new range of models, ranging from Fixed, Tilt and Full-Motion, are all rigorously tested and built to last, with upgraded specifications.

Add the support we offer to help increase the TV attach rate and average sales price, you'll be sure to boost your category performance.

**Vogel's. For Sure.**

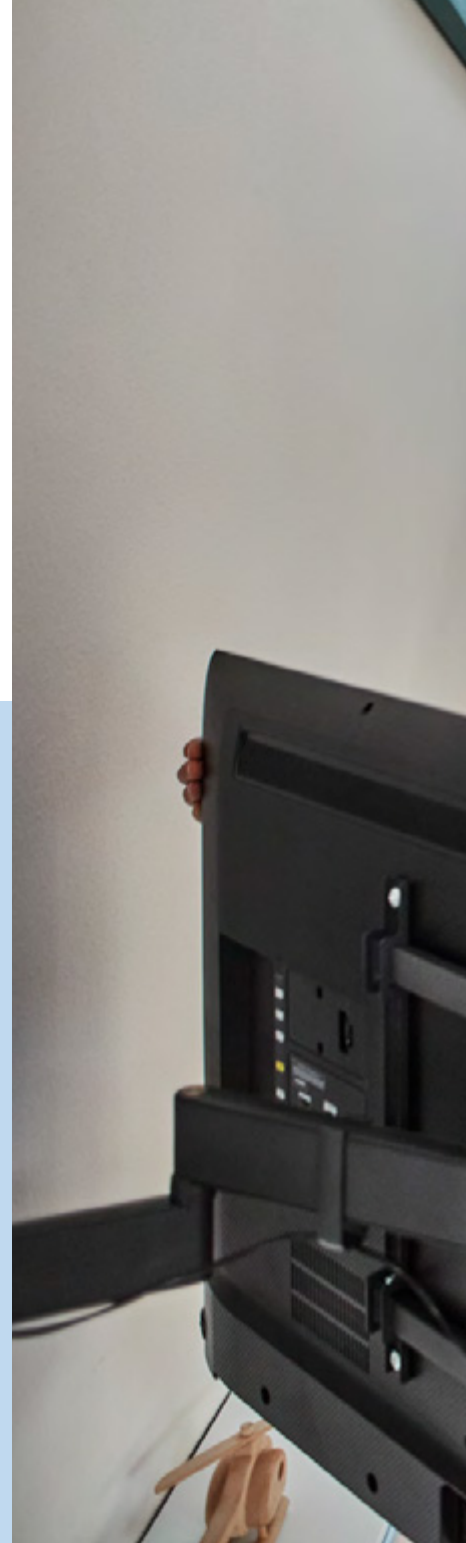



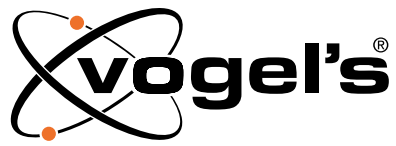

**Volg Vogel's:**



[/VogelsForSure](#)



[/c/VogelsForSure](#)



[/company/vogels](#)



[/VogelsForSure](#)



[/vogels\\_official](#)

**Disclaimer**

While every effort is made to ensure the accuracy of the information provided, Vogel's shall not be held responsible for any errors. This also applies to mistakes or omissions in respect of prices or measurements. Not all products are available in every country.

**Vogel's. For Sure.**