

# ERARD®

## Mounts & furniture for flat TV screens

[www.erard.com](http://www.erard.com)

### 2024

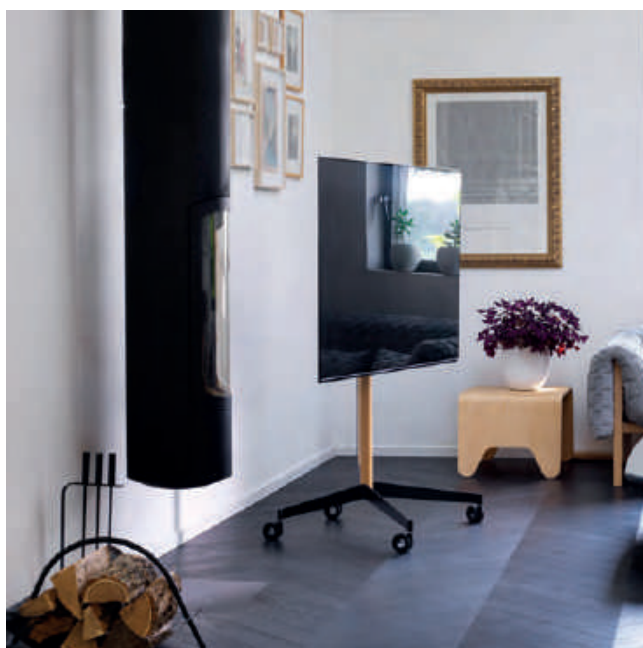

# ERARD®

ESSENTIAL ACCESSORIES  
FOR AUDIO VIDEO COMPONENTS



Wall mounts



Office mounts

# À PROPOS

## AN ESTABLISHED NAME IN AUDIO-VISUAL ACCESSORIES

The ERARD Group specializes in audiovisual materials for use in homes, businesses, industry and public spaces. Its continuing growth draws on the development of 4 companies: ERARD®, ERARD® PRO, ERARD® D3C and ERARD® INDUSTRIE.

**ERARD®** designs and markets solutions for the integration and connection of consumer audiovisual equipment: aerial accessories, mounts, furniture for television sets and connection systems.

**ERARD® Pro** develops and markets solutions for the integration of professional audiovisual equipment: indoor and outdoor enclosures for flat screens, TV columns, video projector mounts...

**ERARD® D3C** is a specialist in audio, video and data signal processing. It manufactures custom-made cables for many sectors: audiovisual, IT, industry, medical... It also markets cables, connectors and leads, well-known for their manufacturing quality.

**ERARD® INDUSTRIE** manufactures ERARD products, providing external companies with co-development and production services as an industrial subcontractor.

## WHAT MAKES THE DIFFERENCE?

**THE STRENGTH OF THE BRAND** : ERARD® has been present on the integrated audiovisual system market for over 50 years. Its products are recognized for their quality design and workmanship.

**ORIGINE FRANCE GARANTIE** : All products manufactured at our factory in Chavanoz (38) are certified by "Origine France Garantie" (certified 'French Origin Guaranteed').

**10 YEAR GUARANTEE** : Through meticulous design and high-quality workmanship, we guarantee all our products for a minimum of 10 years, with some guaranteed for life.

**VISION AND DESIGN** : All of our products are exclusively designed by our R&D department, which is focused on creating stylish, smart and practical products.



TV Floor stands



TV Furniture

# TABLE OF CONTENTS

<b>TECHNICAL GUIDE</b>	<b>6</b>
HOW TO SELECT YOUR MOUNT ? .....	10
VESA COMPATIBILITY FOR MOUNTS .....	12
<b>OFFICE MOUNTS</b>	<b>14</b>
NEXTIA MS1-MS2.....	16
NEXTIA S1-S2-D2.....	18
NEXTIA FS1-FS2.....	20
NEXTIA LT.....	21
<b>WALL MOUNTS</b>	<b>22</b>
APPLIK.....	22
CLIFF .....	28
DO IT.....	34
STANDIT .....	40
EXO STAND .....	44
EXO .....	48
EXO OLED .....	52
FLAK.....	54
ACCESSORIES .....	56
SQUARE .....	58





## TV FLOOR STANDS 60

HOW TO SELECT YOUR FLOOR STAND ?.....	60
VESA COMPATIBILITY FOR FLOOR STAND .....	62
KANA.....	64
WILL.....	72
KROSS .....	78
LUX UP .....	80
FIT UP .....	86

## TV FURNITURE 88

NAGA.....	88
-----------	----

## MERCHANDISING SOLUTIONS 96

## INDEX 98

# Mounts and furniture for flat TV screens

## PICTOGRAM KEY



Screen tilt capacity



Screen swivel capacity



Minimum and maximum distance between wall and screen

The ranges of ERARD TV mounts, units, columns and floor stands are indicated using these pictograms



Fixed mount



Maximum mount capacity



Maximum shelf capacity



Max screen thickness



VESA compatibility



Ultra slim mount



Corner installation possible



Mobile TV stand or column



Safety system preventing falls



Anti-theft system included



Mount compatible with OLED screens



Integrated cable management



Can be painted



Integrated spirit level



Type of screen screws supplied



Height adjustable screen



Screw set and spacers for OLED screens included

# Mounts and furniture for flat TV screens

## ERARD COMPATIBILITY AND SAFETY INFORMATION

### VESA standard



For each ERARD® mount, column and floor stand, there is a pictogram indicating the compatible VESA dimensions.

The VESA standard is the standard followed by TV and wall mount manufacturers.

It specifies the distance between the mounting holes on the back of the TV.

To find out the VESA standard for a television or monitor, simply check the user manual or measure the distance between the mounting holes.

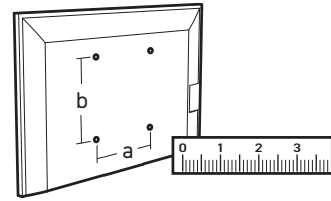

VESA 100 : a = b = 100 mm  
 VESA 200 : a = b = 200 mm  
 etc...  
 VESA 600x400 : a = 600 mm  
 b = 400 mm  
 etc...

### Screen size



For each ERARD® mount, column and floor stand, there is a pictogram indicating the compatible screen sizes.

<b>S</b>	15"-28" 38-71 cm	<b>M</b>	19"-43" 48-109 cm	<b>L</b>	30"-65" 76-165 cm
<b>XL</b>	40"-85" 101-215 cm	<b>XXL</b>	40"-100" 101-254 cm		

This compatibility is given as an indication.

**Larger televisions can be mounted, provided:**

- the TV's VESA measurements are compatible with the ERARD® mount.



- the screen weight does not exceed the maximum weight indicated.



### Screen weight



For each ERARD® mount, column and floor stand, there is a pictogram indicating the maximum admissible weight.



30 Kg

### Screen thickness



For each ERARD® mount, column and floor stand, there is a pictogram indicating the compatible screen thickness.



Maxi  
100 mm

### Safety tests

All of the products developed by ERARD®'s R&D department are designed with a wide margin of safety. Mounts designed for screens weighing less than 30 kg are tested up to 4 times the maximum indicated load. Mounts designed for screens weighing over 30 kg are tested at the maximum indicated load + 88 kg.

## FIXED OR TILTABLE MOUNT



It is entirely possible to install a fixed or tiltable mount on a plasterboard wall of type BA10 or BA13

To do so, we advise beforehand

- to respect any recommendations made by the plasterboard manufacturer
- to ensure that your wall is in good condition
- to use dowels and screws designed for hollow walls (not supplied)

## MOUNT WITH OFFSET



The structure of a plasterboard wall does not allow for the installation of a mount with offset, except when anchoring the mount on a load-bearing wall.

In 2024, ERARD offers you 3 innovative solutions for direct installation on a plasterboard wall.

EXOSTAND : A 'FLOOR-WALL' COLUMN FOR INSTALLATION ON ANY TYPE OF PARTITION WALL

KITS TO INSTALL A CLIFF OR EXO MOUNT ONTO THE METAL RAILS WITHIN A PARTITION WALL



See p46



See p33 for CLIFF  
See p50 for EXO



# ASSEMBLY ON A WALL MOUNT

## FOR IRREGULAR REAR PANELS

## FOR FLAT REAR PANELS

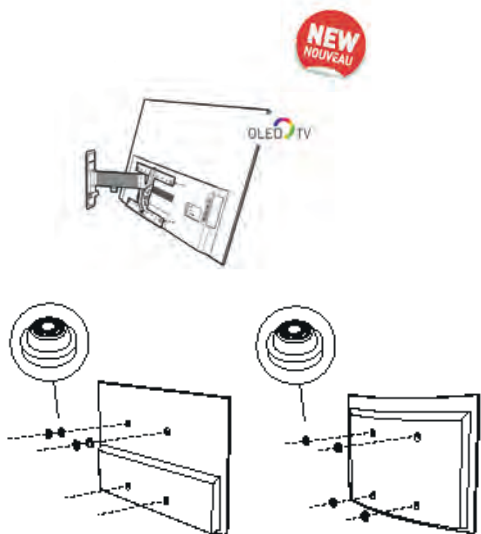

For screens with an electronic block located on the bottom, discover EXO OLED p52

For curved VESA screens or screens with irregular fixation positions, discover TV ADAPT+ our kit.

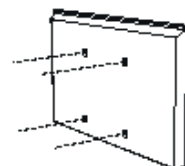

All ERARD mounts are compatible.



# ASSEMBLY ON FOOT

## ASSEMBLY ON KANA TV STAND

## ASSEMBLY ON THE WILL, LUX UP-T AND NAGA RANGES

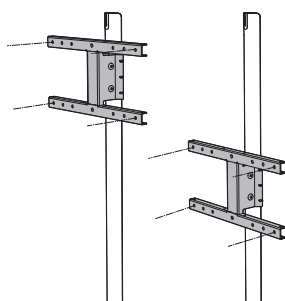

Discover the KANA TV stand p64

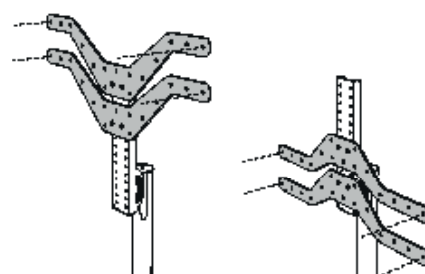

The WILL and LUX UP-T ranges of TV stands and the NAGA column are designed for all types of LCD, LED and OLED screens

# HOW TO SELECT YOUR WALL MOUNT FOR FLATSCREENS IN 3 EASY STEPS



**1** What is the screen size ?

**2** Which functions are required ?

**3** Select your wall mount  
...

... consult the product descriptions\* before making your choice

\*The above chart is based on the technical features of the screens currently available on the market and the features specific to ERARD mounts. Details on these technical features can be found in the product pages of the catalogue.

Customers are asked to factor in the distance between the screen mounting holes (VESA standard) and the maximum mount weight capacity (shown in kilograms) before making their choice.

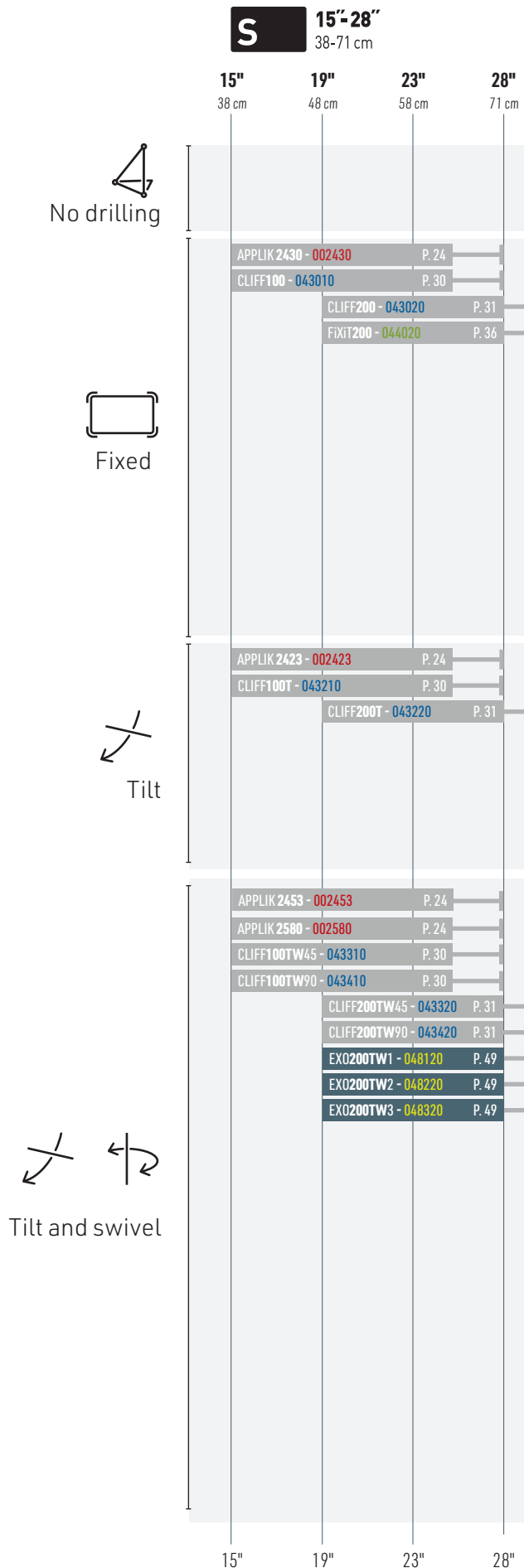

**M** 19"-43"  
48-109 cm

**L** 30"-65"  
76-165 cm

**XL** 40"-85"  
101-215 cm

**XXL** 40"-100"  
101-254 cm

30" 76 cm    32" 81 cm    37" 94 cm    40" 101 cm    43" 109 cm    50" 127 cm    55" 140 cm    60" 150 cm    65" 165 cm    75" 190 cm    85" 215 cm    90" 228 cm    100" 254 cm



STANDIT 400 - 044640	P. 41													
				STANDIT 600 - 044660	P. 41									
				STANDIT PRO - 044661	P.41									
APPLIK 2530 - 002530	P. 27													
APPLIK 2407 - 002407	P. 27													
CLIFF400 - 043040	P. 32													
FIXIT400 - 044040	P. 36													
FIXIT400C - 044042	P.37													
APPLIK 045004 045004	P. 25													
				APPLIK 045007 - 045007	P. 25									
				APPLIK 045040 - 045040	P. 26									
				CLIFF600 - 043060	P. 33									
				FIXIT600 - 044060	P.36									
				FIXIT600C - 044062	P. 36									
APPLIK 2531 - 002531	P. 27													
CLIFF400T - 043240	P. 32													
TILTIT400 - 044240	P. 40													
				APPLIK 045201 - 045201	P. 25									
				CLIFF600T - 043260	P. 33									
CLIFF400TW45 - 043340	P. 32													
CLIFF400TW90 - 043440	P. 32													
TWISTIT400 - 044440	P. 41													
EXO400TW1 - 048140	P. 50													
EXO400TW2 - 048240	P. 50													
EXO400TW3 - 048340	P. 50													
EXOSTAND400 - 048440	P.47													
EXO4000LEDTW3 - 048345	P.52													
				APPLIK 2532 - 002532	P. 26									
				EXO600TW2 - 048260	P. 51									
				EXO600TW3 - 048360	P. 51									
				EXOXXLTW3 - 048390	P. 51									
				EXOSTAND600 - 048460	P. 47									
				EXOSTANDPRO - 048461	P. 47									
				EXO6000LEDTW2 - 048265	P. 52									

30" 32" 37" 40" 43" 50" 55" 60" 65" 75" 85" 90" 100"















# VESA compatibility FOR MOUNTS

12

















## NEXTIA range

					VESA (H x V)																														
Ref.	Description	Page			50x50	75x75	100x100	100x150	150x100	100x200	200x100	200x200	200x300	200x400	300x100	300x200	300x300	300x400	400x100	400x200	400x300	400x400	400x600	500x200	500x300	600x200	600x300	600x400	600x500	800x400	800x500	900x600	1000x600	1200x800	
	Toute la gamme	14-19		2 à 10 Kg																															

## APPLIK Range

					VESA (H x V)																																
Ref.	Description	Page			50x50	75x75	100x100	100x150	150x100	100x200	200x100	200x200	200x300	200x400	300x100	300x200	300x300	300x400	400x100	400x200	400x300	400x400	400x600	500x200	500x300	600x200	600x300	600x400	600x500	800x400	800x500	900x600	1000x600	1200x800			
002407	APPLIK 2407	27		120 Kg																																	
002423	APPLIK 2423	24		15 Kg																																	
002430	APPLIK 2430	24		15 Kg																																	
002453	APPLIK 2453	24		15 Kg																																	
002530	APPLIK 2530	25		120 Kg																																	
002531	APPLIK 2531	25		120 Kg																																	
002532	APPLIK 2532	24		60 Kg																																	
002580	APPLIK 2580	24		15 Kg																																	
045004	APPLIK 045004	23		70 kg																																	
045007	APPLIK 045007	23		70 Kg																																	
045040	APPLIK 045040	24		120 Kg																																	
045201	APPLIK 045201	23		70 Kg																																	

## CLIFF Range

					VESA (H x V)																																
Ref	Description	Page			50x50	75x75	100x100	100x150	150x100	100x200	200x100	200x200	200x300	200x400	300x100	300x200	300x300	300x400	400x100	400x200	400x300	400x400	400x600	500x200	500x300	600x200	600x300	600x400	600x500	800x400	800x500	900x600	1000x600	1200x800			
043010	CLIFF100	30		15 Kg																																	
043020	CLIFF200	31		30 Kg																																	
043040	CLIFF400	32		30 Kg																																	
043060	CLIFF600	33		30 Kg																																	
043210	CLIFF100T	30		15 Kg																																	
043220	CLIF 200T	31		30 Kg																																	
043240	CLIFF400T	32		30 Kg																																	
043260	CLIFF600T	33		30 Kg																																	
043310	CLIFF100TW45	30		15 Kg																																	
043320	CLIFF200TW45	31		30 Kg																																	
043340	CLIFF400TW45	32		30 Kg																																	
043410	CLIFF100TW90	30		15 Kg																																	
043420	CLIFF200TW90	31		30 Kg																																	
043440	CLIFF400TW90	32		30 Kg																																	





NEXTIA, a range of desktop mounts for monitors

NEXTIA offers a range of monitor mounts perfectly adapted to the needs of both the office and home office. Safe, fully adjustable (height, tilt and swivel) and particularly easy to handle, the NEXTIA mounts contribute to creating comfortable work spaces.

Ref 011108 NEXTIA TW **New**



Ref 011100 NEXTIA S-1 **New**



Ref 011102 NEXTIA S-2 **New**



Ref 011105 NEXTIA D-2 **New**



Ref 011200 NEXTIA MS-1 **New**



Ref 011205 NEXTIA MD-2 **New**



Ref 011112 NEXTIA FS-2 **New**



Ref 011115 NEXTIA FD-2 **New**



Ref 011109 NEXTIA LT-S **New**



# NEXTIA

10 YEAR WARRANTY

## NEXTIA MS-1 and MD-2, mobile desk mounts for PC, monitor and headset

- Universal mount for monitors up to 32" and 10 kg
- Universal bracket for audio headset
- Storage space for PC and keyboard
- Integrated cable management
- Can be fixed to a desk (fixing clamp supplied)
- Solid steel structure
- Aluminium arm
- Adjustable articulations (tilt and swivel)
- Adjustable arm height

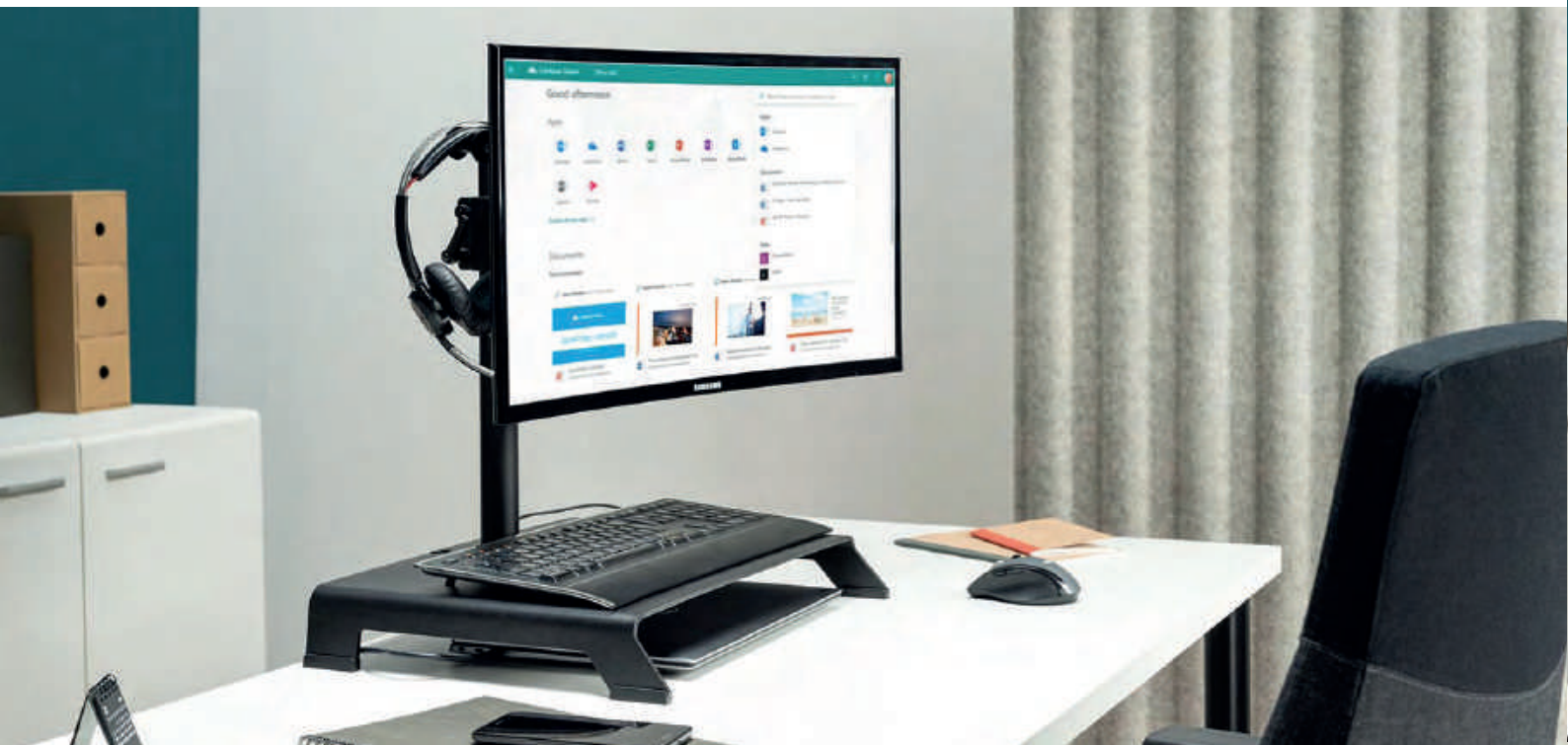

**New** NEXIA MS-1

Ref 011200

EAN 318528 011200 5

TILT AND SWIVEL MOBILE DESK MOUNT WITH DOCK

**S** 15"-32"  
38 - 81 cm

- +/-10°
- 180°
- 10 kg
- Vesa 75 > 100
- Safety system

Cable management



Universal mount for monitors up to 32" and 10 kg

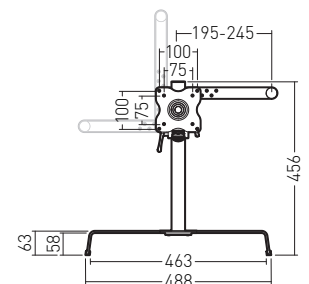
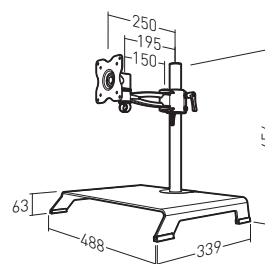

**+** Practical, compact and complete solution for optimum use of the workspace





**New** NEXTIA MD-2

Ref 011205 EAN 3 18528 011205 0 TILT AND SWIVEL MOBILE DESK MOUNT WITH DOCK, 2 ARMS

**S** 15"-27"  
38 - 81 cm

-  +/-10°
-  180°
-  2 x 8kg
-  Vesa 75 > 100
-  Safety system

  
Cable management



Universal mount for 2 monitors up to 27" and 2x8kg

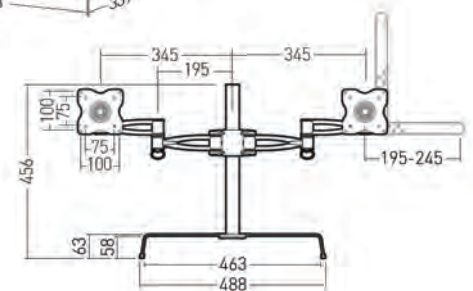
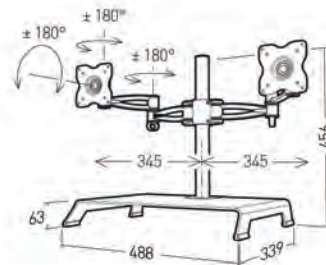

# Office mounts

## NEXTIA

10 YEAR WARRANTY

18

### NEXTIA TW, S1, S2 and D2 desktop mounts for computer monitor, tilt and swivel

- A secure clamp mechanism ensures a firm hold on the desk or work surface, for high stability of the whole unit.
- The monitor height is adjustable (by over 40 cms) and features both +/-15° monitor tilt and 360° swivel capacity, allowing greater versatility for daily use.
- Great flexibility in the articulations for easier handling and user satisfaction.

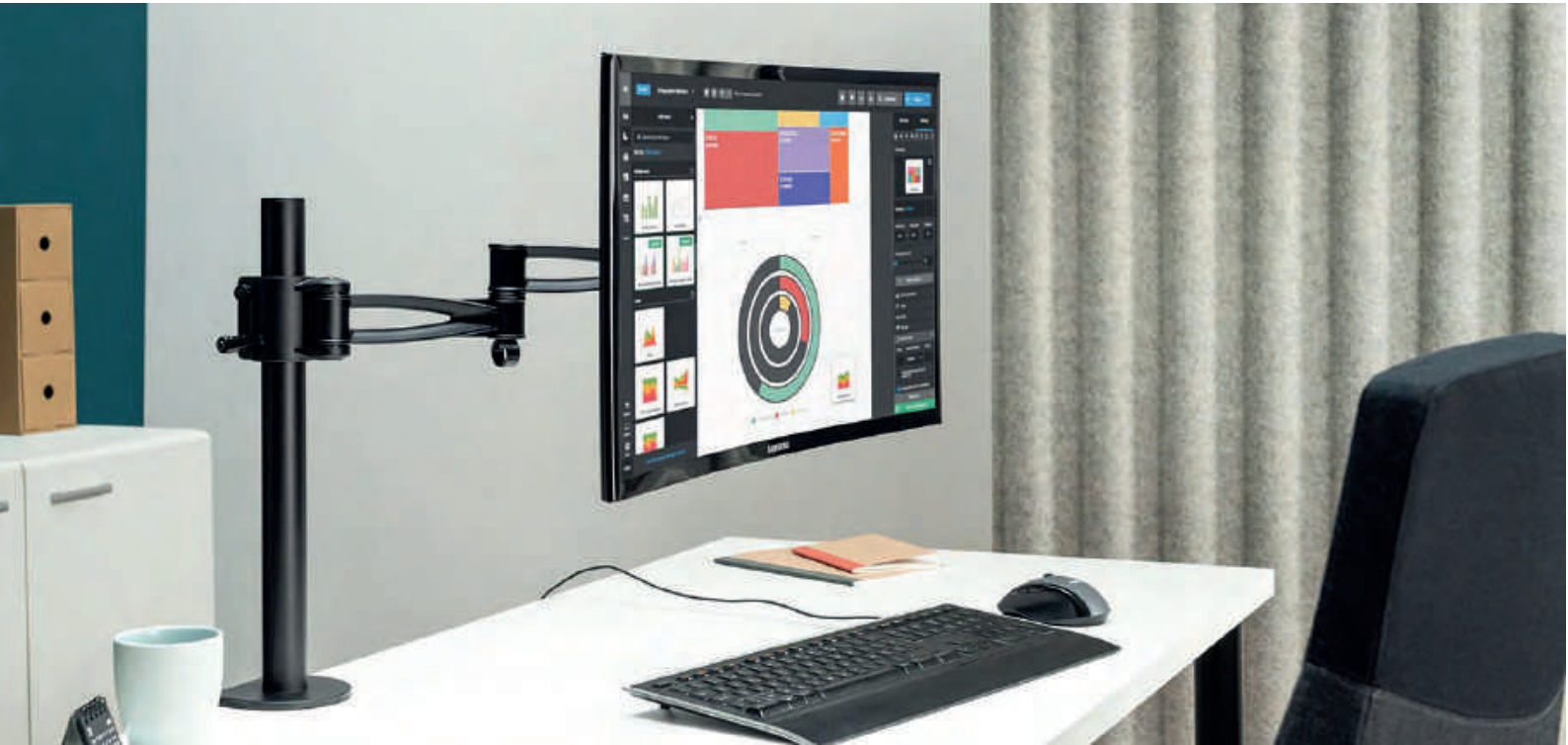

#### New **NEXTIA TW**

Ref **011108**

EAN 3 18528 011108 4

DESKTOP MOUNT FOR COMPUTER MONITOR, TILT AND SWIVEL



**S** 15"-32"  
38 - 82 cm

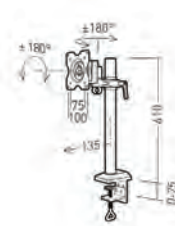

#### New **NEXTIA S-1**

Ref **011100**

EAN 318528 011100 8

DESKTOP MOUNT FOR COMPUTER MONITOR, TILT AND SWIVEL



**S** 15"-32"  
38 - 82 cm

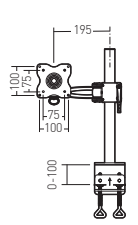
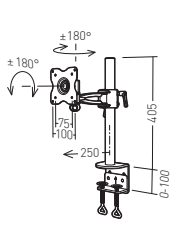

# Office mounts NEXTIA

10 YEAR WARRANTY

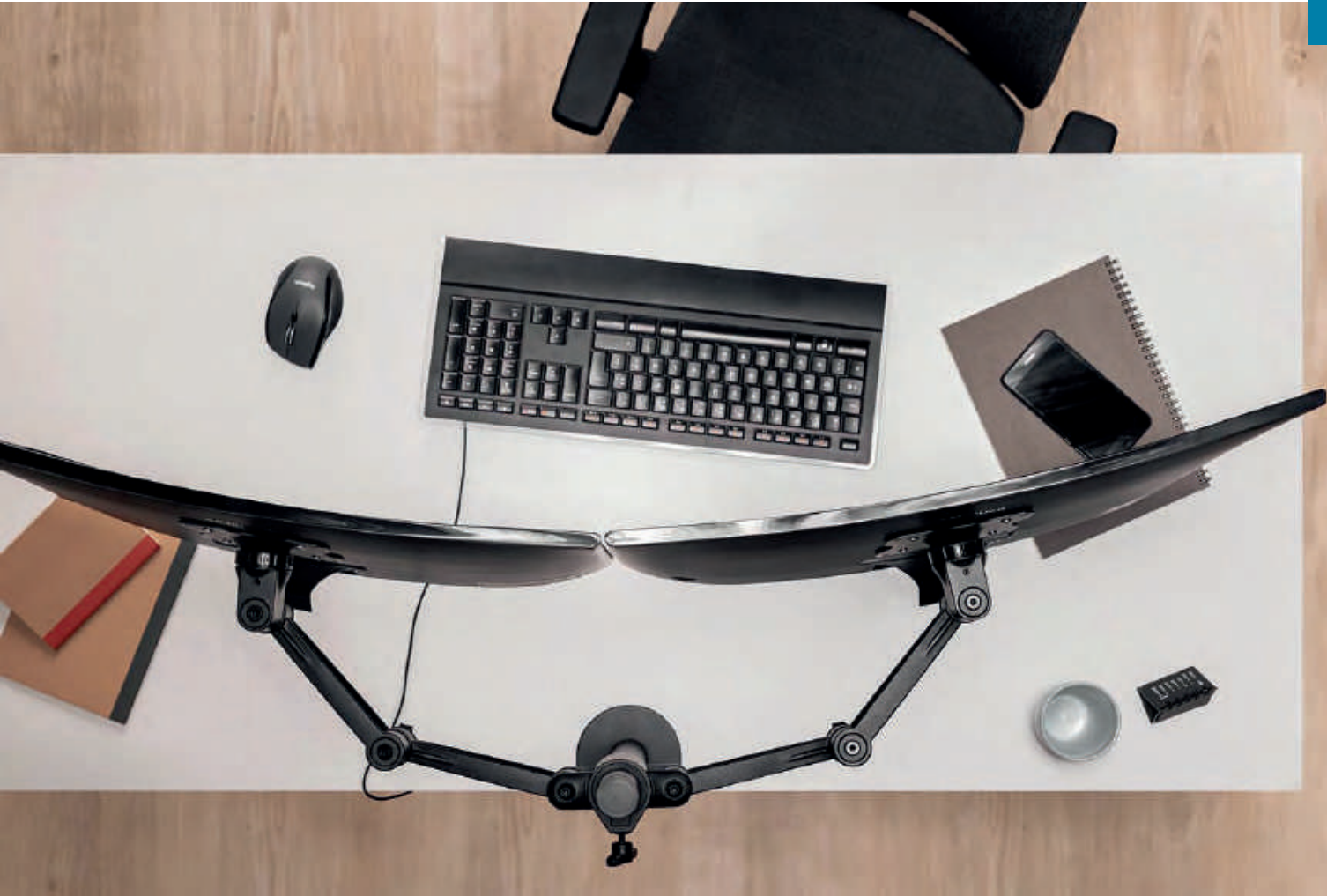

**New** NEXTIA **S**-2

Ref 011102 EAN 3 18528 011102 2 DESKTOP MOUNT FOR COMPUTER MONITOR, TILT AND SWIVEL

**S** 15"-32"  
38 - 82 cm

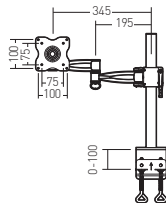
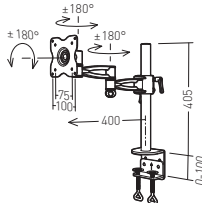

**New** NEXTIA **D**-2

Ref 011105 EAN 3 18528 011105 3 DESKTOP MOUNT FOR TWO COMPUTER MONITORS, TILT AND SWIVEL- FOR MONITORS 15" TO 27"

**S** 15"-27"  
38 - 69 cm

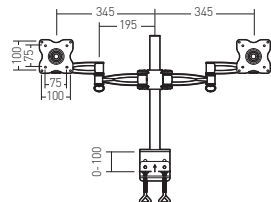
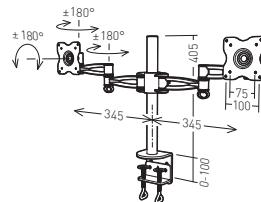

# Office mounts

## NEXTIA

2 YEAR WARRANTY

**+** Ergonomic arm for easy height adjustment on the pole. Ideal for use while in a standing position

20

### NEXTIA FS-2 and FD-2, Tilt and swivel desk mounts with articulated arm with gas springs

- Great amplitude for adjustment of the mount height - up to 63 cms (max position screen centre)
- Easy adjustment of the monitor height with an auto-balance of 27 cms
- Can support a weight of up to 8 kg
- Aluminium and steel structure, grainy black epoxy paint finish
- Cables are hidden (in the upper part of the arm)
- Fixed by a secure clamp on a desk or work surface with a thickness of up to 10 cms
- Tools are provided for assembly and balancing adjustment as well as for fine-tuning the articulations.



#### New **NEXTIA FS-2**

Ref **011112** EAN 318528 011112 1

TILT AND SWIVEL DESK MOUNT WITH ARTICULATED ARM WITH GAS SPRINGS



**S** 15"-32"  
38 - 81 cm



+/-10°

180°

2 à 9 kg

Vesa  
75 > 100

Cable  
management

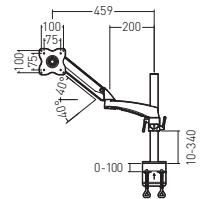
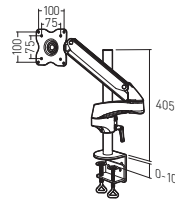

#### New **NEXTIA FD-2**

Ref **011115** EAN 318528 011115 2

TILT AND SWIVEL DESK MOUNT WITH 2 ARTICULATED ARMS WITH GAS SPRINGS



**S** 15"-32"  
38 - 81 cm



+/-10°

180°

2x 8 kg

Vesa  
75 > 100

Cable  
management

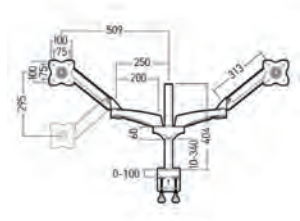
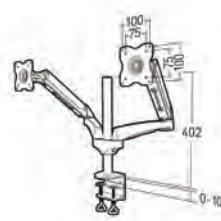

**NEXTIA LT-S - Foldable and Adjustable Laptop Stand**

- Quickly folds away, easily transportable,
- Adjustable viewing angle: 6 different levels
- Solid aluminum structure for excellent durability
- 4 silicone anti-slip mats
- Can support a weight of up to 16 kgs
- For laptops up to 15.6" and tablets
- Soft protective pouch included



**New** NEXTIA **LT-S**

Ref **011109**

EAN 3 18528 011109 1

FOLDABLE AND ADJUSTABLE LAPTOP STAND

**S** **15,6"**  
0 - 38 cm

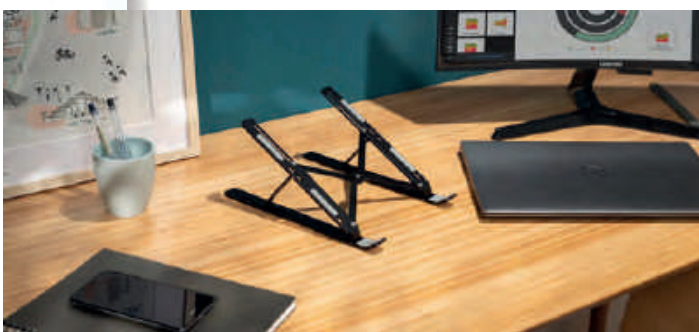
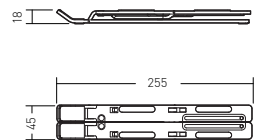
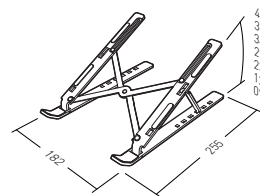



## APPLIK, a range of economic and universal mounts

APPLIK mounts meet all installation needs, whatever the layout of the space and the weight or dimensions of your screen (up to 120 kg for universal versions). Sturdy, practical and of high quality, you are guaranteed a secure, reliable installation.

Ref 002430 APPLIK 2430



Ref 002423 APPLIK 2423



Ref 002453 APPLIK 2453



Ref 002580 APPLIK 2580



Ref 002407 APPLIK 2407



Ref 002530 APPLIK 2530



Ref 002531 APPLIK 2531



Ref 045004 APPLIK 045004 **New**



Ref 045007 APPLIK 045007



Ref 045201 APPLIK 045201



Ref 045040 APPLIK 045040



Ref 002532 APPLIK 2532



# Wall mounts for small budgets

## APPLIK

0 YEAR WARRANTY 1

24

### Applik for small screens from 15" to 28"

- Wall mount and mounting plate made of steel.
- Black epoxy paint finish.

#### APPLIK 2430

Ref 002430

EAN 318528 002430 8

FIXED MOUNT FOR 15" - 28" SCREENS

**S** 15"-28"  
38 - 71 cm

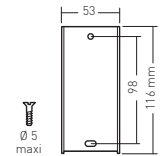
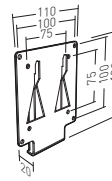

#### APPLIK 2423

Ref 002423

EAN 318528 002423 0

TILTING MOUNT FOR 15" - 28" SCREENS

**S** 15"-28"  
38 - 71 cm

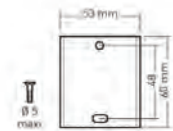
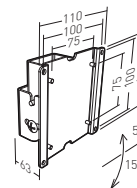

#### APPLIK 2453

Ref 002453

EAN 318528 002453 7

TILT AND SWIVEL MOUNT FOR 15" - 28" SCREENS

**S** 15"-28"  
38 - 71 cm

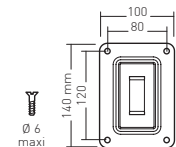
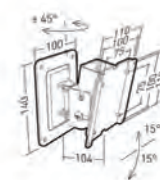
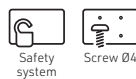

#### APPLIK 2580

Ref 002580

EAN 318528 002580 0

TILT AND SWIVEL MOUNT WITH OFFSET FOR 15" - 28" SCREENS

**S** 15"-28"  
38 - 71 cm

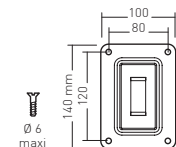
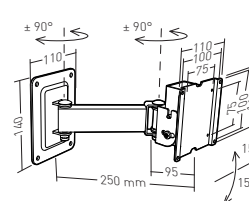
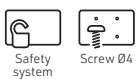



## Applik for large screens from 30" to 85"

- Wall mount and mounting plate made of steel.
- Black epoxy paint finish.

### New APPLIK **045004**

Ref **045004** EAN 318528 045004 6 FIXED MOUNT FOR 30" - 65" SCREENS

**L** 30"-65"  
76 - 165 cm

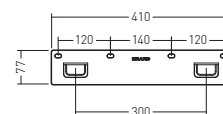
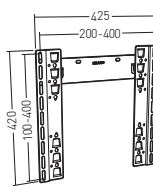

### APPLIK **045007**

Ref **045007** EAN 318528 045007 7 FIXED MOUNT FOR 40" - 85" SCREENS

**XL** 40"-85"  
101 - 215 cm

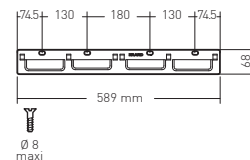
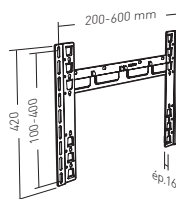
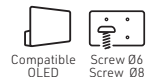

### APPLIK **045201**

Ref **045201** EAN 318528 045201 9 TILT MOUNT FOR 40" - 85" SCREENS

**XL** 40"-85"  
101 - 215 cm

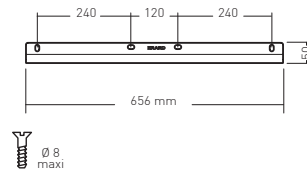
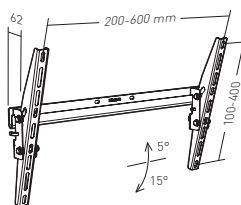
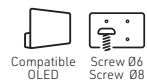

# Wall mounts for small budgets

## APPLIK

10 YEAR WARRANTY



BVCert. 6164725

### Applik for very large screens from 40" to 100"

- Wall mount and mounting plate made of steel.
- Black epoxy paint finish.

#### APPLIK 045040

Ref 045040

EAN 318528 045040 4

FIXED MOUNT FOR 40" - 100" SCREENS



**XXL** 40"-100"  
101 - 254 cm

- 41,50 mm
- Fixe
- 120 kg
- Vesa 200 > 1250x800
- Safety system
- Compatible OLED
- Screw Ø6
- Screw Ø8

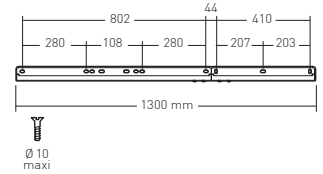
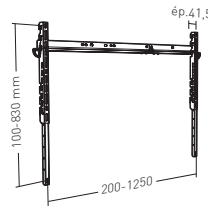

#### APPLIK 2532

Ref 002532

EAN 318528 002532 9

TILT AND SWIVEL MOUNT WITH OFFSET FOR 40" - 85" SCREENS



**XL** 40"-85"  
101 - 215 cm

- +5/-15°
- +/-90°
- 380 - 550 mm
- 60 kg
- Vesa 200 > 800
- Safety system
- Compatible OLED
- Cable management
- Screw Ø6
- Screw Ø8

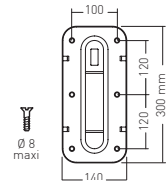
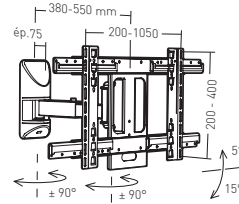

## Universal Applik

- Wall mount and mounting plate made of steel.
- Black epoxy paint finish.
- Breakable wall plate to adapt to all screen sizes.

- +** Ensures a perfectly secure installation of extra-large screens in public spaces

### APPLIK 2530

Ref **002530**

EAN 318528 002530 5

UNIVERSAL FIXED WALL MOUNT

**U** **30" et plus**  
76 cm

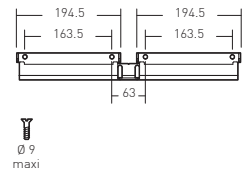
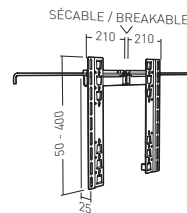
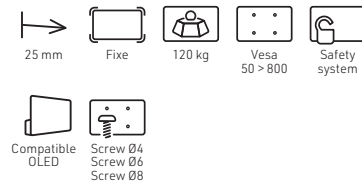

### APPLIK 2407

Ref **002407**

EAN 318528 002407 0

UNIVERSAL FIXED WALL MOUNT

**U** **30" et plus**  
76 cm

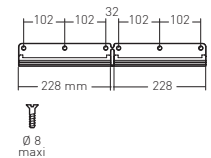
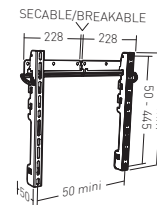
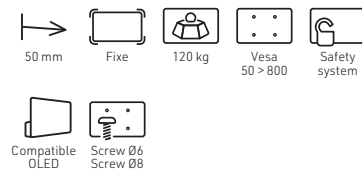

### APPLIK 2531

Ref **002531**

EAN 318528 002531 2

UNIVERSAL TILT WALL MOUNT

**U** **30" et plus**  
76 cm

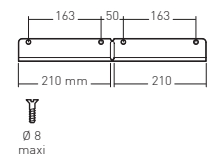
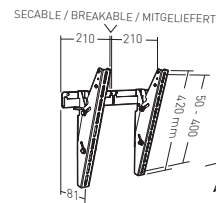
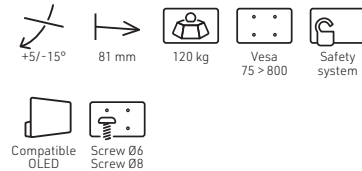

### Anti-theft rod

Ref **002552**

EAN 318528 002552 7

COMPATIBLE WITH APPLIK MOUNT **2407**

- Rod length: 760 mm.
- Rod diameter: 8 mm.
- White zinc-plated finish.
- Padlock provided.



### Anti-theft cable

Ref **012395**

EAN 318528 012395 7

- 2 mounting sockets + 600 aircraft cable + lock + node fitting

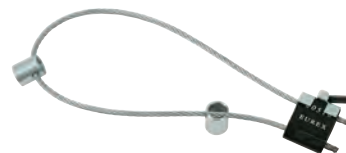



**CLIFF, simple and effective !**

Since being launched, CLIFF mounts have been a hit with consumers and installers. The rounded screen plate, the grooved arms, the built-in spirit level and the choice of colours really make this range stand out from the crowd. And with 14 options to choose from, you are sure to find the right mount for your TV.

Ref 043010 CLIFF100



Ref 043210 CLIFF100T



Ref 043310 CLIFF100TW45



Ref 043410 CLIFF100TW90



Ref 043020 CLIFF200



Ref 043220 CLIFF200T



Ref 043320 CLIFF200TW45



Ref 043420 CLIFF200TW90



Ref 043040 CLIFF400



Ref 043240 CLIFF400T



Ref 043340 CLIFF400TW45



Ref 043440 CLIFF400TW90



Ref 043060 CLIFF600



Ref 043260 CLIFF600T



## Cliff for small screens from 15" to 28"

- Wall mount and mounting plate made of steel.
- Black and silver epoxy paint finish.
- Integrated spirit level.

### CLIFF100

Ref **043010**

EAN 318528 043010 9

FIXED MOUNT FOR 15" - 28" SCREENS

**S** 15"-28"  
38 - 71 cm

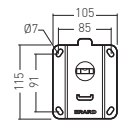
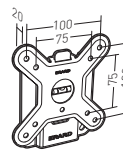
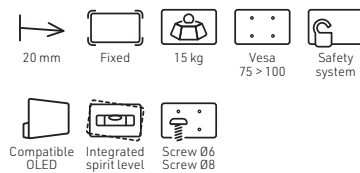

### CLIFF100T

Ref **043210**

EAN 318528 043210 3

TILTING MOUNT FOR 15" - 28" SCREENS

**S** 15"-28"  
38 - 71 cm

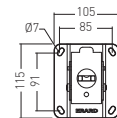
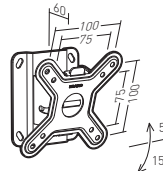
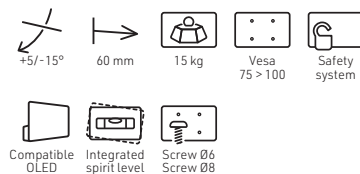

### CLIFF100TW45

Ref **043310**

EAN 318528 043310 0

TILT AND SWIVEL MOUNT FOR 15" - 28" SCREENS

**S** 15"-28"  
38 - 71 cm

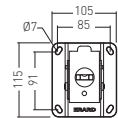
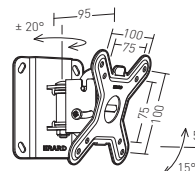
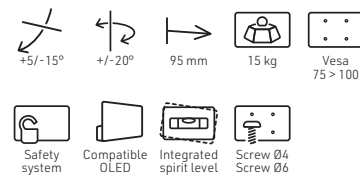

### CLIFF100TW90

Ref **043410**

EAN 318528 043410 7

TILT AND SWIVEL MOUNT WITH OFFSET FOR 15" - 28" SCREENS

**S** 15"-28"  
38 - 71 cm

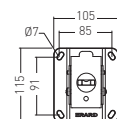
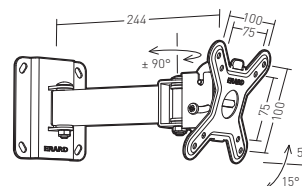
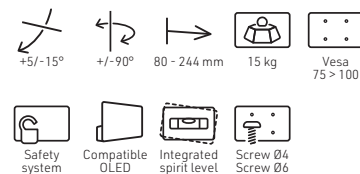

Cliff for medium size screens from 19" to 43"

- Wall mount and mounting plate made of steel.
- Black and silver epoxy paint finish.
- Integrated spirit level.

**CLIFF200**

Ref **043020**

EAN 318528 043020 8

FIXED MOUNT FOR 19" - 43" SCREENS



**M** 19"-43"  
48 - 109 cm

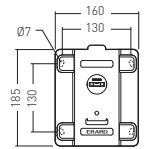
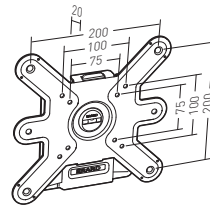
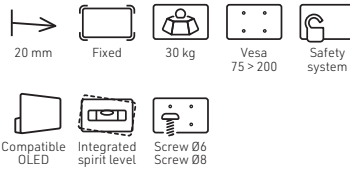

**CLIFF200T**

Ref **043220**

EAN 318528 043220 2

TILTING MOUNT FOR 19" - 43" SCREENS



**M** 19"-43"  
48 - 109 cm

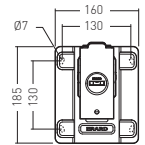
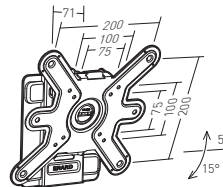
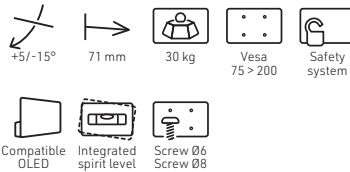

**CLIFF200TW45**

Ref **043320**

EAN 318528 043320 9

TILT AND SWIVEL MOUNT FOR 19" - 43" SCREENS



**M** 19"-43"  
48 - 109 cm

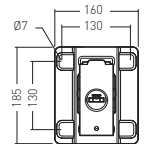
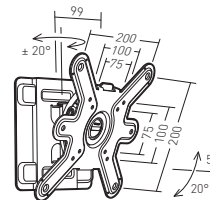
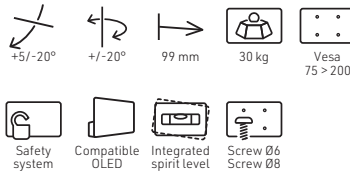

**CLIFF200TW90**

Ref **043420**

EAN 318528 043420 6

TILT AND SWIVEL MOUNT WITH OFFSET FOR 19" - 43" SCREENS



**M** 19"-43"  
48 - 109 cm

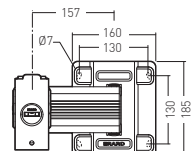
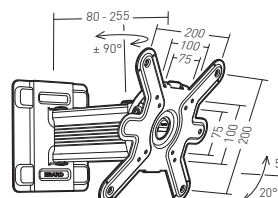
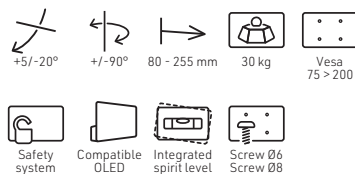

## Cliff for large screens from 30" to 65"

- Wall mount and mounting plate made of steel.
- Black and silver epoxy paint finish.
- Integrated spirit level.

### CLIFF400

Ref **043040**

EAN 318528 043040 6

FIXED MOUNT FOR 30" - 65" SCREENS



**L** 30"-65"  
76 - 165 cm

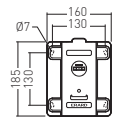
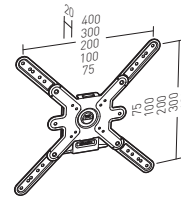
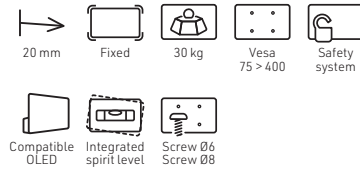

### CLIFF400T

Ref **043240**

EAN 318528 043240 0

TILTING MOUNT FOR 30" - 65" SCREENS



**L** 30"-65"  
76 - 165 cm

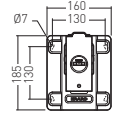
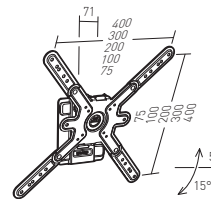
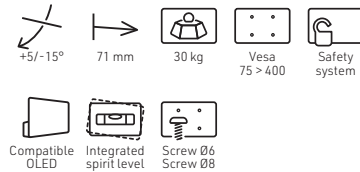

### CLIFF400TW45

Ref **043340**

EAN 318528 043340 7

TILT AND SWIVEL MOUNT FOR 30" - 65" SCREENS



**L** 30"-65"  
76 - 165 cm

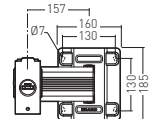
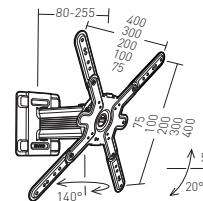
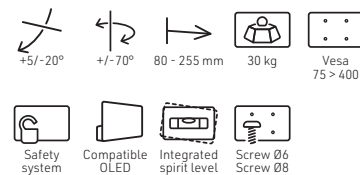

### CLIFF400TW90

Ref **043440**

EAN 318528 043440 4

TILT AND SWIVEL MOUNT WITH OFFSET FOR 30" - 65" SCREENS



**L** 30"-65"  
76 - 165 cm

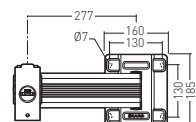
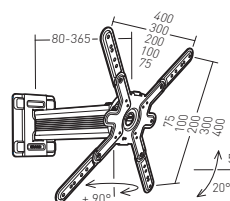
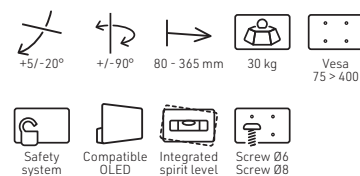



## Cliff for very large screens from 40" to 85"

- Wall mount and mounting plate made of steel.
- Black and silver epoxy paint finish.
- Integrated spirit level.

### CLIFF600

Ref **043060**

EAN 318528 043060 4

FIXED MOUNT FOR 40" - 85" SCREENS

**XL** 40"-85"  
101 - 215 cm

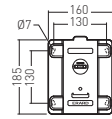
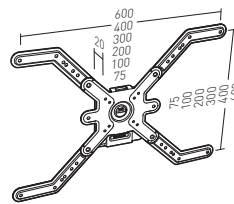

### CLIFF600T

Ref **043260**

EAN 318528 043260 8

TILTING MOUNT FOR 40" - 85" SCREENS

**XL** 40"-85"  
101 - 215 cm

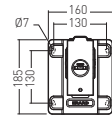
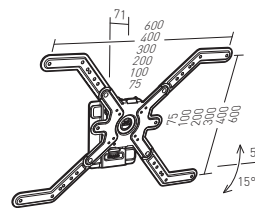
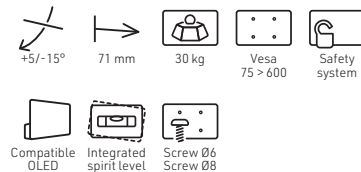

## CLIFF KIT FOR PLASTERBOARD

Ref **043490**

EAN 318528 043490 9

FIXING KIT FOR PLASTERBOARD, FOR CLIFF MOUNTS

- Kit to be fixed on the metal rails of the plasterboards.
- Designed specifically for the installation of CLIFF 200-400-600 T, TW45 and TW90 mounts.
- Delivered with a special magnet to detect the rails, a set of 6 FISCHER screws and expansion tool.

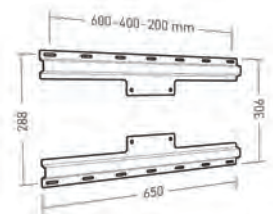



**Do iT - innovation for flat screens**

The consumers and installers we spoke to had two main considerations which we took into account when designing our Do iT mounts: easy and safe installation; and being able to mount the screen as close as possible to the wall (like you would with a painting).

A firm favourite for their eccentric lock washers, which help to compensate for any drilling mishaps, FIXiT, TiLTiT and TWiSTiT mounts also boast an ingenious mechanism for locking and unlocking the screen, allowing any necessary work to be carried out quickly, following installation. Do iT also features STANDiT, the only wall mount with no drilling required! Often imitated, never equalled.

Ref 044020 **FIXiT200**



Ref 044040 **FIXiT400**



Ref 044060 **FIXiT600**



Ref 044042 **FIXiT400C**



Ref 044062 **FIXiT600C**



Ref 044240 **TiLTiT400**



Ref 044440 **TWiSTiT400**



Ref 044640 **STANDiT 400**



Ref 044660 **STANDiT 600**



Ref 044661 **STANDiT PRO**



FiXiT, fixed wall mounts for flat screens from 19" to 85"

- Wall mount and mounting plate made of steel.
- Eccentric lock washers to correct drilling mistakes.
- Safety system to prevent falls.
- Integrated spirit level.

**+** The simplicity of an intervention on the screen after its installation



www.erard-fixit.com

FiXiT 200

Ref **044020** EAN 318528 044020 7

**M** 19"-43"  
48 - 109 cm



16 - 32 mm	Fixed	50 kg	Vesa 75 > 200	Safety system
Compatible OLED	Integrated spirit level	Vis Ø4 Vis Ø6 Vis Ø8		

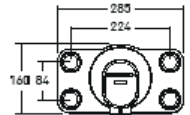
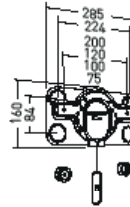

FiXiT 400

Ref **044040** EAN 318528 044040 5

**L** 30"-65"  
76 - 165 cm



16 - 32 mm	Fixed	60 kg	Vesa 200 > 400	Safety system
Compatible OLED	Integrated spirit level	Vis Ø4 Vis Ø6 Vis Ø8		

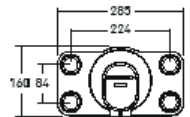
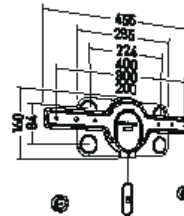

FiXiT 600

Ref **044060** EAN 318528 044060 3

**XL** 40"-85"  
101 - 215 cm



16 - 32 mm	Fixed	70 kg	Vesa 200 > 600	Safety system
Compatible OLED	Integrated spirit level	Vis Ø4 Vis Ø6 Vis Ø8		

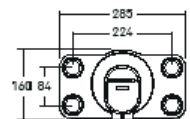
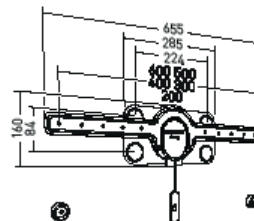

**FiXiT C, fixed wall mount for 30"-85" screens with curved or irregular rear panel**

- Wall mount and mounting plate made of steel.
- Eccentric lock washers to correct horizontality after drilling.
- Safety system to prevent falls.
- Integrated spirit level.
- Contains a set of spacers (registered design) and screws

required to install a screen with curved or irregular back panel (Kit Adapt+).

- Compatible all screen types (LCD, LED, QLED, OLED).

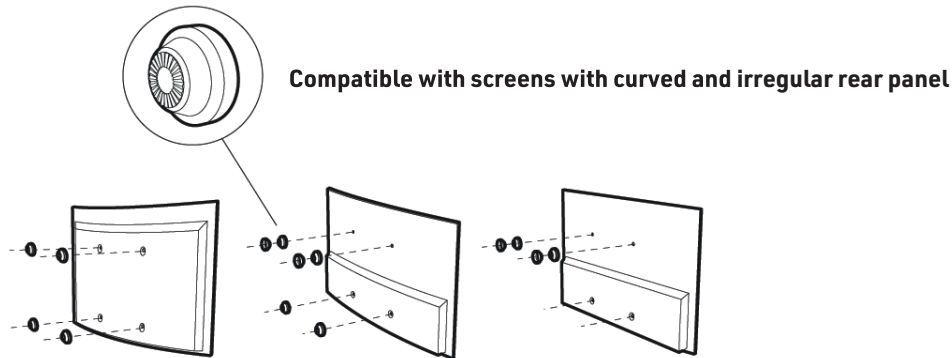

**FiXiT 400C**

Ref **044042** EAN 318528 044042 9



**L** 30"-65"  
76 - 165 cm

- 16 - 32 mm
- Fixed
- 60 kg
- Vesa 200 > 400
- Safety system

- Compatible Oled
- Integrated spirit level
- Vis 04  
Vis 06  
Vis 08

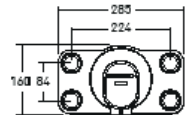
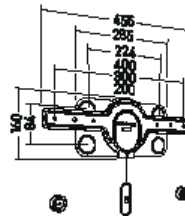

**FiXiT 600C**

Ref **044062** EAN 318528 044062 7



**XL** 40"-85"  
101 - 215 cm

- 16 - 32 mm
- Fixed
- 70 kg
- Vesa 200 > 600
- Safety system

- Compatible Oled
- Integrated spirit level
- Vis 04  
Vis 06  
Vis 08

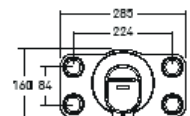
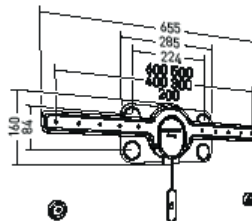

**TiLTiT, tilting wall mount for flat screens from 30" to 65"**

- Wall mount and mounting plate made of steel.
- Eccentric lock washers to correct drilling mistakes.
- Safety system to prevent falls.
- Integrated spirit level.



www.erard-tiltit.com

**TiLTiT400**

Ref **044240**

EAN 318528 044240 9

TILTING MOUNT FOR 30" - 65" SCREENS



**30"-65"**  
76 - 165 cm

+0/-25°	30 mm	30 kg	Vesa 200 > 400	Safety system
Compatible OLED	Integrated spirit level	Vis Ø4 Vis Ø6 Vis Ø8		

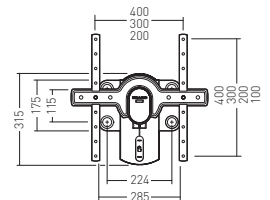
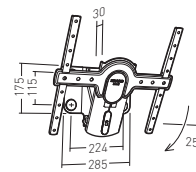

**TWiSTiT, tilt and swivel wall mount for flat screens from 30" to 65"**

- Wall mount and mounting plate made of steel.
- Eccentric lock washers to correct drilling mistakes.
- Safety system to prevent falls.
- Integrated spirit level.
- Sliding telescopic arm.
- Adjustable wall offset up to 710 mm.



www.erard-twistit.com

**TWiSTiT400**

Ref **044440**

EAN 318528 044440 3

TILT AND SWIVEL MOUNT WITH OFFSET FOR 30" - 65" SCREENS



**30"-65"**  
76 - 165 cm

+0/-25°	+/-90°	58 - 710 mm	30 kg	Vesa 200 > 400
Angle	Safety system	Compatible OLED	Cable management	Integrated spirit level
Vis Ø4 Vis Ø6 Vis Ø8				

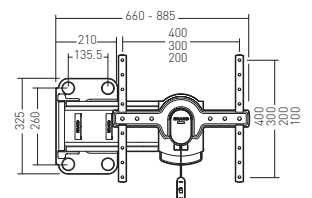
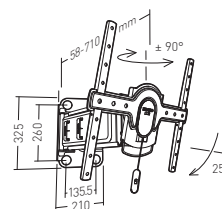



**STANDiT: the only wall mount with no drilling required!**

STANDiT is the only wall mount with no drilling required. The choice of materials, the size of the base and the design of its column make it a secure solution that could not be easier to install. Highly practical, it is ideal for tenants, events professionals and installers looking for a unique and stylish product.



www.erard-standit.com



**STANDiT™**

**An innovative concept for wallmounting your TV without drilling.**



① **3 POINT SUPPORT GEOMETRY**  
STABILITY BASED ON THE LAWS OF PHYSICS:  
FEET ARE FAR AHEAD OF THE CENTRE OF GRAVITY



② **THICK STEEL STRUCTURE**  
THICK STEEL STRUCTURE GUARANTEES  
RIGIDITY AND STABILITY OF THE UNIT



③ **STABILIZING PAD**  
STABILIZING PAD ENSURES THE SCREEN GRIPS TO THE WALL  
WHILE CUSHIONING EVERYDAY KNOCKS AND BUMPS.

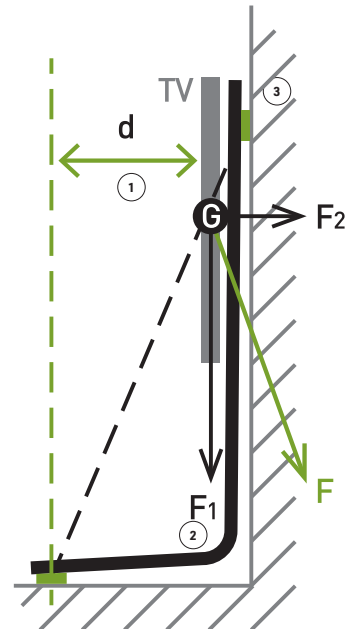

Stabilizing pad ensures the screen grips to the wall while cushioning everyday knocks and bumps



Antifall device for the screen and incorporated cable management



STANDiT Pro: Delivered with possibility of fixing by drilling for public places



STANDit 400

Ref 044640 EAN 318528 044640 7

FIXED ULTRA-SLIM NO-DRILL MOUNT FOR 30"-65" SCREENS

**L** 30"-65"  
76 - 165 cm

- 30 mm
- 30 kg
- Maxi 50 mm
- Vesa 200 > 400
- Safety system
- Cable management
- Paintable
- Screw Ø6
- Screw Ø8
- Adapt+ kit included

STANDit 600

Ref 044660 EAN 318528 044660 5

FIXED ULTRA-SLIM NO-DRILL MOUNT FOR 40"-85" SCREENS

**XL** 40"-85"  
101 - 215 cm

- 30 mm
- 45 kg
- Maxi 60 mm
- Vesa 200 > 600
- Safety system
- Cable management
- Paintable
- Screw Ø6
- Screw Ø8
- Adapt+ kit included

STANDit PRO

Ref 044661 EAN 318528 044661 2

FIXED ULTRA-SLIM-NO DRILL MOUNT FOR 40"-100" SCREENS

**XXL** 40"-100"  
101 - 254 cm

- 30 mm
- 50 kg
- Maxi 60 mm
- Vesa 200 > 600
- Safety system
- Cable management
- Paintable
- Screw Ø6
- Screw Ø8
- Adapt+ kit included

If wall mounting of the security bracket:  
80 mm max thickness for the screen.

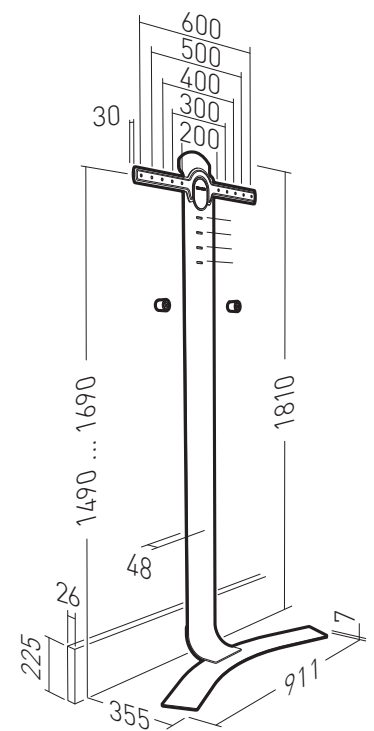
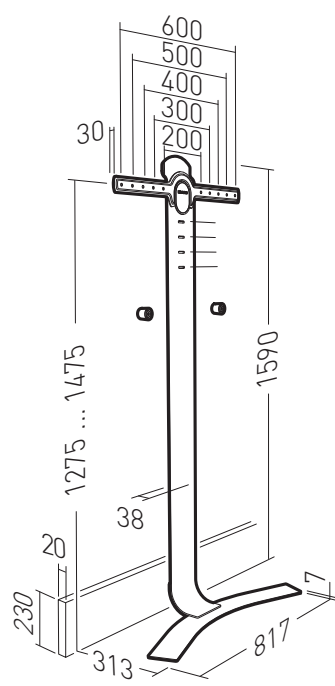
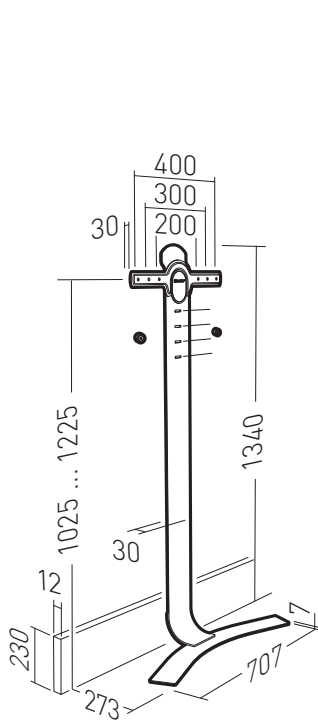

CAMERA SHELF

Ref 044762 for STAND IT 600 EAN 3 18528 044762 6  
Ref 044767 for STAND IT Pro EAN 3 18528 044767 1



Easy and secure attachment with magnets and screws  
Opening to fix the camera to the shelf

Ref: 044762

Ref: 044767

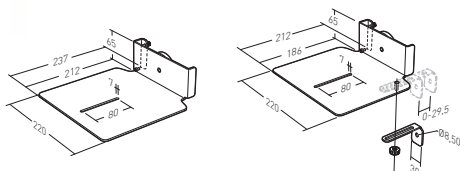

MEDIA PLAYER MOUNT

Ref 044690 EAN 3 18528 044690 2



Can be placed anywhere at the rear on the StandIt column  
Use-ful dimensions : 2 spaces of 200mm in length x 40mm in depth

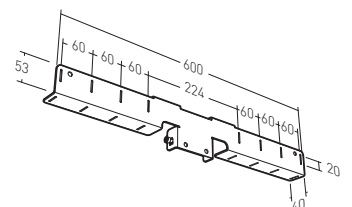



## EXO, Design and Precision !

With its titanium-coloured anodized aluminum arms, EXO is designed to match aesthetic codes of modern TVs. EXO is a very simple mount to install (it comes pre-assembled) and is very pleasant to use. No force is needed, the flexible hinges mean that the screen can be effortlessly moved into the right position.

EXO is also EXOSTAND, a new and unique solution which (finally!) lets you install your mount safely onto a plasterboard wall.

Ref 048440 EXOSTAND400



Ref 048460 EXOSTAND600



Ref 048461 EXOSTANDPRO



Ref 048120 EXO200TW1



Ref 048220 EXO200TW2



Ref 048320 EXO200TW3



Ref 048140 EXO400TW1



Ref 048240 EXO400TW2



Ref 048340 EXO400TW3



Ref 048260 EXO600TW2



Ref 048360 EXO600TW3



Ref 048390 EXOXXLTW3



Ref 048345 EXO 400LEDTW3 **New**



Ref 048265 EXO 600LEDTW2 **New**







## COMPATIBLE WITH PLASTERBOARD

1ST MOUNT REALLY COMPATIBLE WITH PLASTERBOARD\*

### EXOSTAND, an all-in-one wall mount for plasterboard

The newest addition to the EXO range of aluminium wall mounts.

In response to a growing demand for an offset mount compatible with plasterboard, ERARD designed EXOSTAND.

Formed of a column, a mount and a shelf, this all-in-one solution is the first of its kind to be properly compatible with plasterboard walls.

With EXOSTAND, gone are the days of fastening onto wall studs or load-bearing walls.

EXOSTAND also lets you easily adjust the height of the screen and the shelf after installation.



### EXOSTAND A new concept for plasterboard walls

With its T shape and tall, rigid structure, part of the load is absorbed by the ground, meaning 6 times less stress on your wall

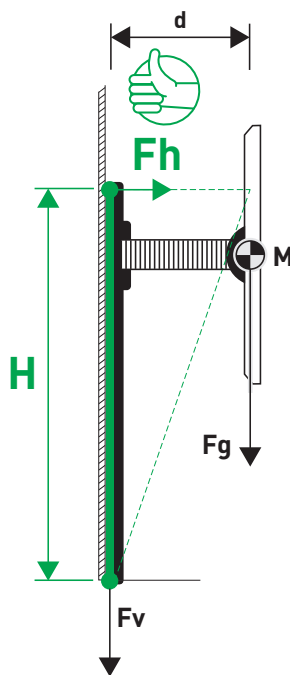

$$F_h = M \times G \times d / H$$

**F<sub>h</sub>** = horizontal tensile force (Nm)  
**M** = mass at the center of gravity (Kg)  
**G** = gravitational constant (9.81)  
**d** = distance from the centre of gravity (m)  
**H** = height between top and bottom points (m)

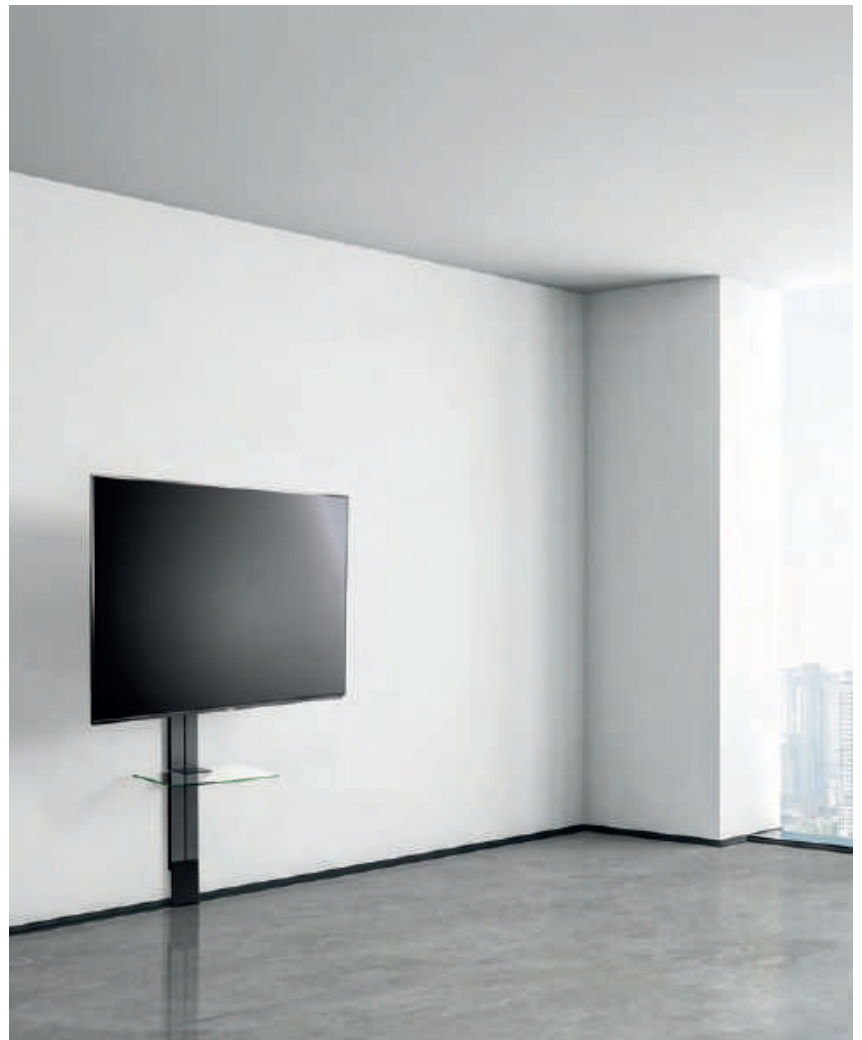

\* Our pull tests conducted with a load of 123 kg on common plasterboard type "BA13" (thickness 12.5 mm) guarantee a perfect fix on your wall, without the need to attach to the studs.

# Aluminium wall mounts

## EXO

LIFETIME WARRANTY



Patented eccentric lock washers to correct drilling mistakes.



3 fastening points

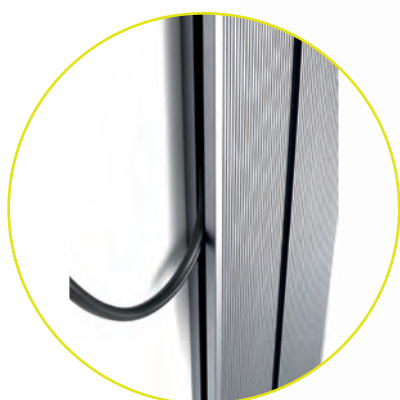

Cable management in the column



Mount height can be adjusted after installation

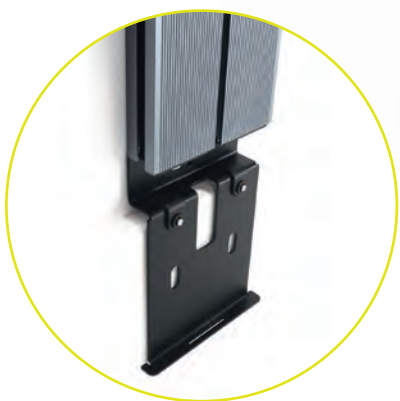

Space left for baseboard

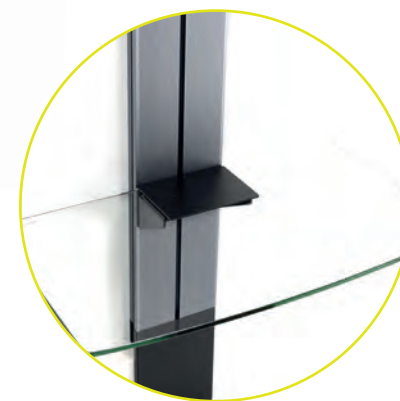

Removable and height adjustable shelf



# Aluminium wall mounts

## EXO

LIFETIME WARRANTY

### EXOSTAND400

Ref **048440** EAN 318528 048440 9

COLUMN + TILT AND SWIVEL MOUNT WITH OFFSET FOR 30"-65" SCREENS

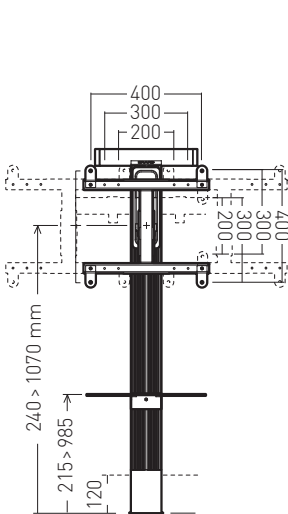
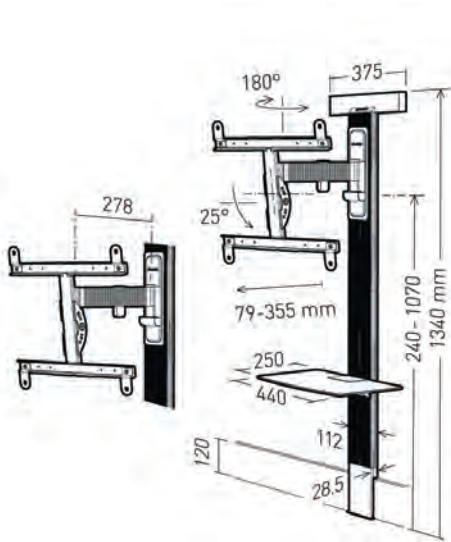
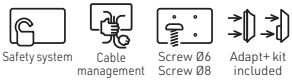
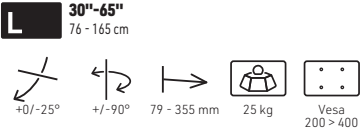

### EXOSTAND600

Ref **048460** EAN 318528 048460 7

COLUMN + TILT AND SWIVEL MOUNT WITH OFFSET FOR 40"-85" SCREENS

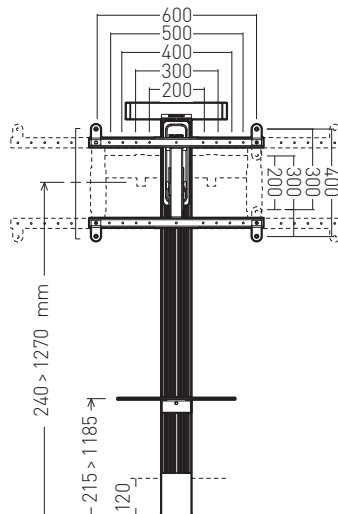
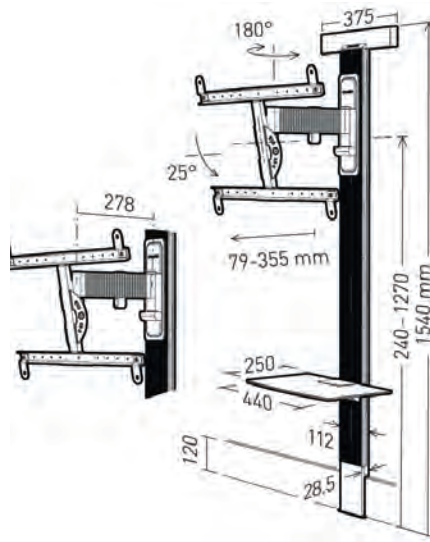
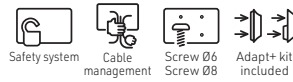
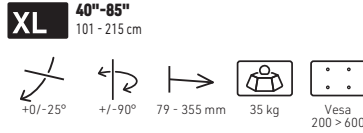

### EXOSTANDPRO

Ref **048461** EAN 318528 048461 4

COLUMN + TILT AND SWIVEL MOUNT WITH OFFSET FOR 40"-85" SCREENS

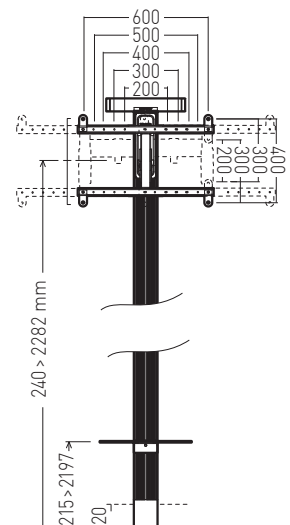
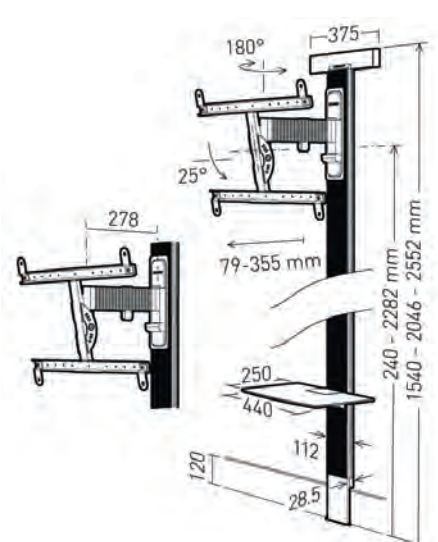
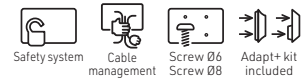
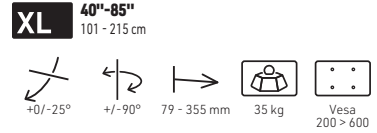

### EXO, Design and Precision !

With its titanium-coloured anodized aluminum arms, EXO is designed to match aesthetic codes of modern TVs. EXO is a very simple mount to install (it comes pre-assembled) and is very pleasant to use. No force is needed, the flexible hinges mean that the screen can be effortlessly moved into the right position.



Patented eccentric lock washers to correct drilling mistakes.



Texturized anodized aluminium arm.



Continuous tilt up to -25°



Micro adjustable levelling system to guarantee perfect horizontality of the screen (EXO 400 and EXO600)

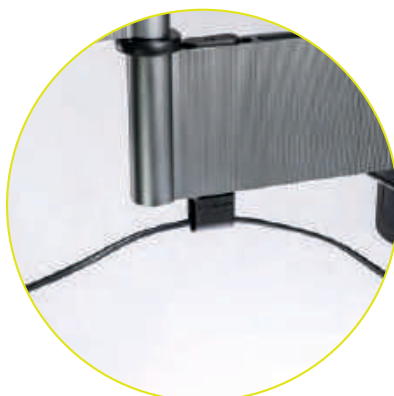

Cable management



Continuous, tool-less tilt adjustment + possibility to adjust the friction.



### EXO 200, for medium size screens from 19" to 43"

- Texturized anodized aluminium arm, titanium coloured.
- Screen and wall mount made of steel, black epoxy paint finish.
- Magnetic cover for wall mount.
- Delivered pre-assembled.



www.erard.com/exo200

#### EXO200TW1

Ref **048120** EAN 318528 048120 0

TILT AND SWIVEL MOUNT WITH OFFSET FOR 19"-43" SCREENS

**M** 19"-43"  
48 - 109 cm

+0/-15° +/-30° 47 - 122 mm 15 kg Vesa 50 > 200

Safety system Compat. OLED Screw Ø4 Screw Ø6 Screw Ø8

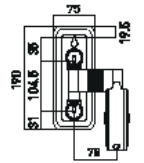
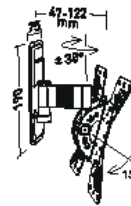

#### EXO200TW2

Ref **048220** EAN 318528 048220 7

TILT AND SWIVEL MOUNT WITH OFFSET FOR 19"-43" SCREENS

**M** 19"-43"  
48 - 109 cm

+0/-15° +/-90° 47 - 240 mm 15 kg Vesa 50 > 200

Safety system Compat. OLED Cable management Screw Ø4 Screw Ø6 Screw Ø8

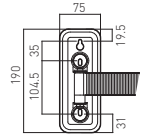
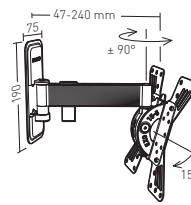

#### EXO200TW3

Ref **048320** EAN 318528 048320 4

TILT AND SWIVEL MOUNT WITH OFFSET FOR 19"-43" SCREENS

**M** 19"-43"  
48 - 109 cm

+/-15° +/-90° 47 - 410 mm 15 kg Vesa 50 > 200

Safety system Compat. OLED Cable management Screw Ø4 Screw Ø6 Screw Ø8

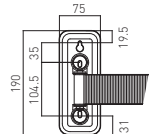
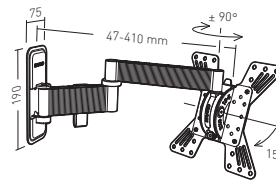

#### EXO POS DISPLAY

Ref **002856** EAN 318528 002856 6

FREESTANDING POS DISPLAY - WIDTH 40 CM

- 2 mm steel structure.
- 19 mm wood panels.
- Demo product EXO400TW3 included.



# Aluminium wall mounts

## EXO

LIFETIME WARRANTY

50

### EXO 400, for large screens from 30" to 65"

- Texturized anodized aluminium arm, titanium coloured.
- Screen and wall mount made of steel, black epoxy paint finish.
- Magnetic cover for wall mount.
- Contains a set of spacers and screws required to install a screen with curved or irregular rear panel (Adapt+ Kit).

- Compatible all screen types (LCD, LED, QLED, OLED).
- Delivered pre-assembled.



www.erard.com/exo400-600

#### EXO400TW1

Ref **048140** EAN 318528 048140 8

TILT AND SWIVEL MOUNT WITH OFFSET FOR 30"-65" SCREENS

**30"-65"**  
76 - 165 cm

+0/-25° +/-30° 49 - 125 mm 25 kg Vesa 200 > 400

Safety system Compatible Oled Cable management Screw Ø6 Screw Ø8 Adapt+ kit included

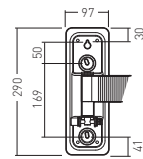
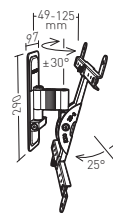

#### EXO400TW2

Ref **048240** EAN 318528 048240 5

TILT AND SWIVEL MOUNT WITH OFFSET FOR 30"-65" SCREENS

**30"-65"**  
76 - 165 cm

+0/-25° +/-90° 49 - 325 mm 25 kg Vesa 200 > 400

Safety system Compatible Oled Cable management Screw Ø6 Screw Ø8 Adapt+ kit included

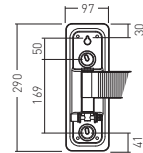
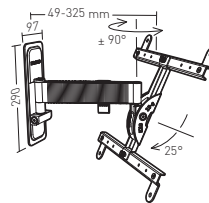

#### EXO400TW3

Ref **048340** EAN 318528 048340 2

TILT AND SWIVEL MOUNT WITH OFFSET FOR 30"-65" SCREENS

**30"-65"**  
76 - 165 cm

+0/-25° +/-90° 49 - 538 mm 25 kg Vesa 200 > 400

Safety system Compatible Oled Cable management Screw Ø6 Screw Ø8 Adapt+ kit included

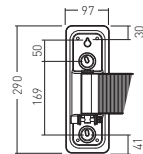
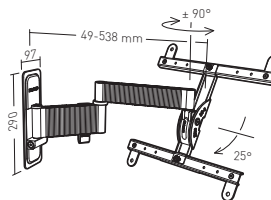

#### EXO KIT FOR PLASTERBOARD

Ref **048380** EAN 3 18528 048380 8

#### EXO KIT FOR PLASTERBOARD

- Kit to be fixed on the metal rails within the plasterboard wall.
- Designed specifically to install the EXO400TW1, EXO400 and EXO600 TW2, TW3 and EXO OLED mounts

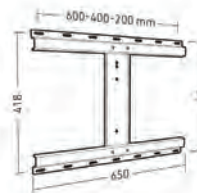

### EXO 600, for large screens from 40" to 85"

- Texturized anodized aluminium arm, titanium colour.
- Screen and wall mount made of steel, black epoxy paint finish.
- Magnetic cover for wall mount.
- Delivered with a kit of spacers and screws required to installation a screen with curved or irregular back panel (Adapt+ Kit).
- Compatible with all screen types

- (LCD, LED, QLED, OLED).
- Delivered pre-assembled.



[www.erard.com/exo400-600](http://www.erard.com/exo400-600)

### EXO600TW2

Ref **048260** EAN 3 18528 048260 3

TILT AND SWIVEL MOUNT WITH OFFSET FOR 40"-85" SCREENS



**XL** 40"-85"  
101 - 215 cm

+0/-25°    +/-70°    49 - 325 mm    35 kg    Vesa 200 > 600

Safety system    Compat. Oled    Cable management    Screw Ø6 Screw Ø8    Adapt+ kit included

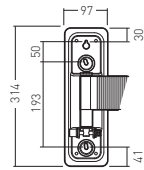
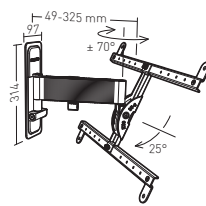

### EXO600TW3

Ref **048360** EAN 3 18528 048360 0

TILT AND SWIVEL MOUNT WITH OFFSET FOR 40"-85" SCREENS



**XL** 40"-85"  
101 - 215 cm

+0/-25°    +/-90°    49 - 538 mm    35 kg    Vesa 200 > 600

Safety system    Compatible Oled    Cable management    Screw Ø4 Screw Ø6 Screw Ø8    Adapt+ kit included

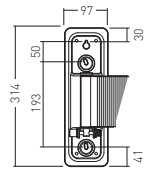
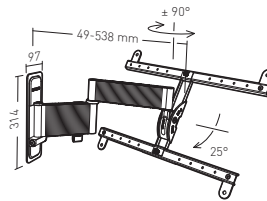

### EXO XXL, for very large screens from 40" to 100"

- Texturized anodized aluminium arm, titanium coloured.
- Screen and wall mount made of steel, black epoxy paint finish.
- Magnetic cover for wall mount.
- Delivered with a kit of spacers and screws required for an installation of a screen with curved or irregular rear panel (Adapt+ kit).

- Compatible with all screen types (LCD, LED, QLED, OLED).
- Delivered pre-assembled.



[www.erard.com/exoxxl](http://www.erard.com/exoxxl)

### EXOXXLTW3

Ref **048390** EAN 3 18528 048390 7

TILT AND SWIVEL MOUNT WITH 530 MM OFFSET FOR 40"-100" SCREENS



**XXL** 40"-100"  
101 - 254 cm

+/-15°    +/-80°    68 - 530 mm    70 kg    Vesa 200x100 > 600x400

Safety system    Compatible Oled    Cable management    Screw Ø6 Screw Ø8    Kit adapt+ included

- Large wall plate: 307 mm
- Possibility to swivel up to 160°

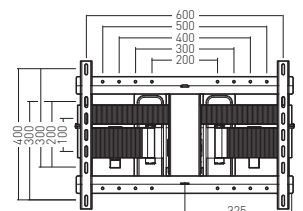
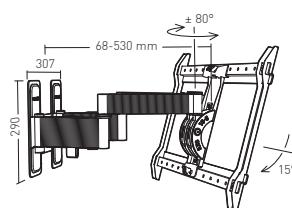

EXO OLED, the range for large screens up to 85"

EXO OLED mounts have been designed to highlight the finest of OLED TVs. Adapted to all models, including those with a low electronic block, a successful installation is guaranteed. Their quality of finish and comfort of use are remarkable and satisfy the expectations of the

most demanding users, both in terms of aesthetics and of use.

For more information on OLED screens, see our Technical Guide on page 9.

EXO 400OLED TW3



Ref 048345 EAN 318528 048345 7

**L** 30"-65"  
76 - 165 cm

- +0/-15°
- +/-90°
- 49 - 538 mm
- 25 kg
- Vesa 200 > 400
- Safety system
- Compatible Oled
- Cable management
- Screw Ø6  
Screw Ø8
- Adapt+ kit included

TILT AND SWIVEL WALL MOUNT WITH 538MM OFFSET FOR OLED TVs

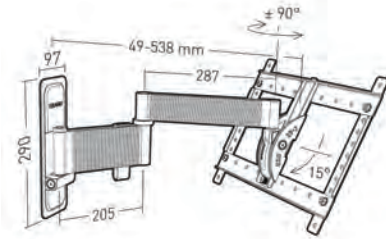
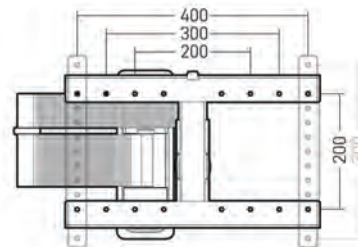

EXO 600OLED TW2



Ref 048265 EAN 318528 048265 8

**XL** 40"-85"  
101 - 215 cm

- +0/-15°
- +/-70°
- 49 - 325mm
- 35 kg
- Vesa 200 > 600
- Safety system
- Compatible Oled
- Cable management
- Screw Ø4  
Screw Ø6  
Screw Ø8
- Adapt+ kit included

TILT AND SWIVEL WALL MOUNT WITH 325MM OFFSET 325MM FOR OLED SCREENS TVs

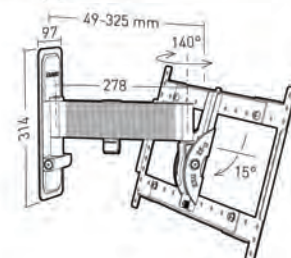
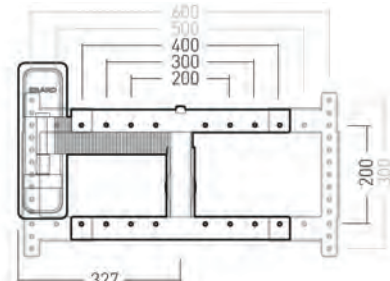



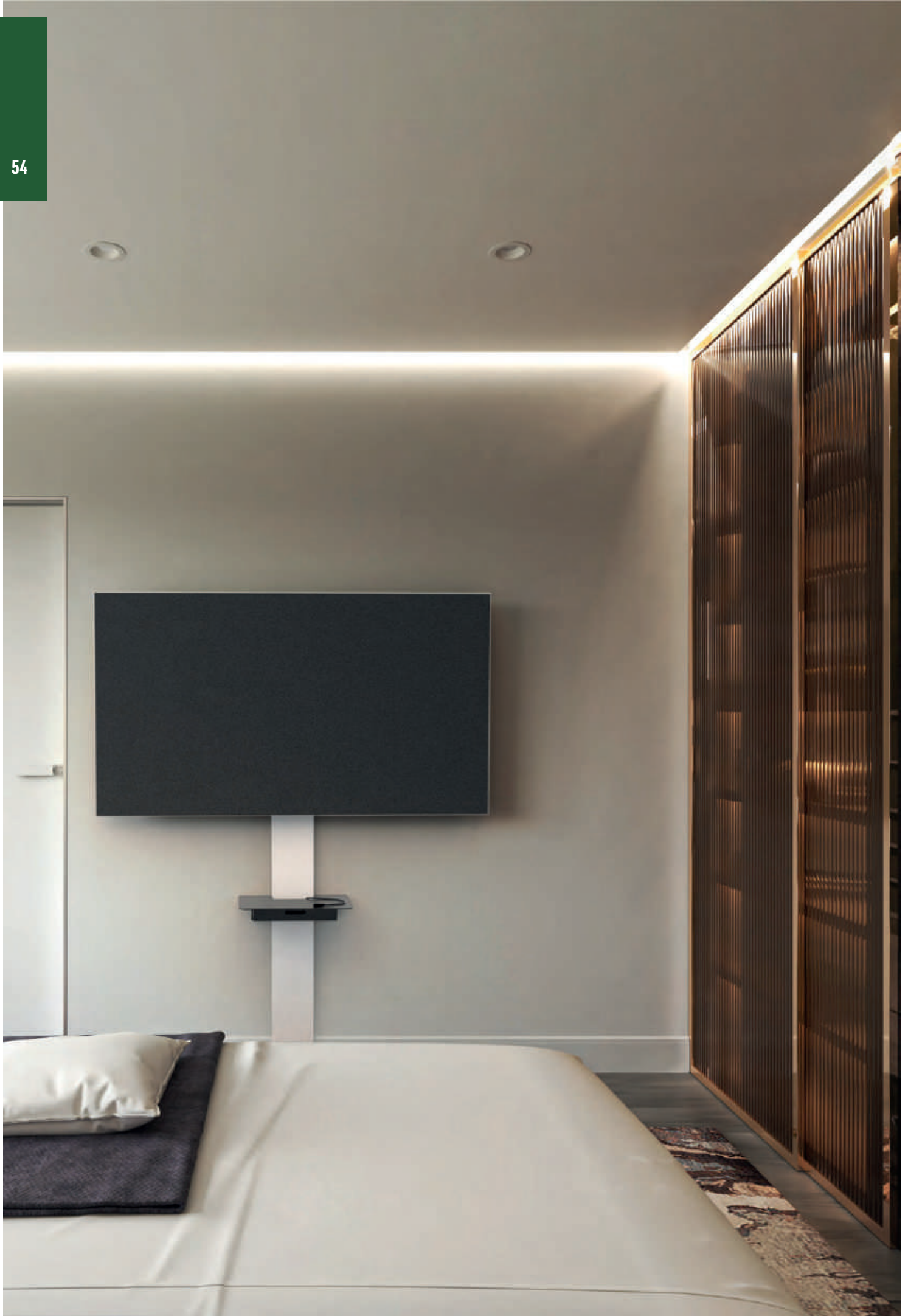

Wall station to place, connect and charge portable device

Ideal for use in a bedroom, a lounge or a meeting room, FLAK allows you to hide away the cables of your audiovisual installation, to place and connect your mobile devices, to store your chargers or your remotes.

**New** FLAK800+

Ref 035450

EAN 318528 035450 4

CABLE COVER WITH DOCKING SHELF FOR A PORTABLE DEVICE

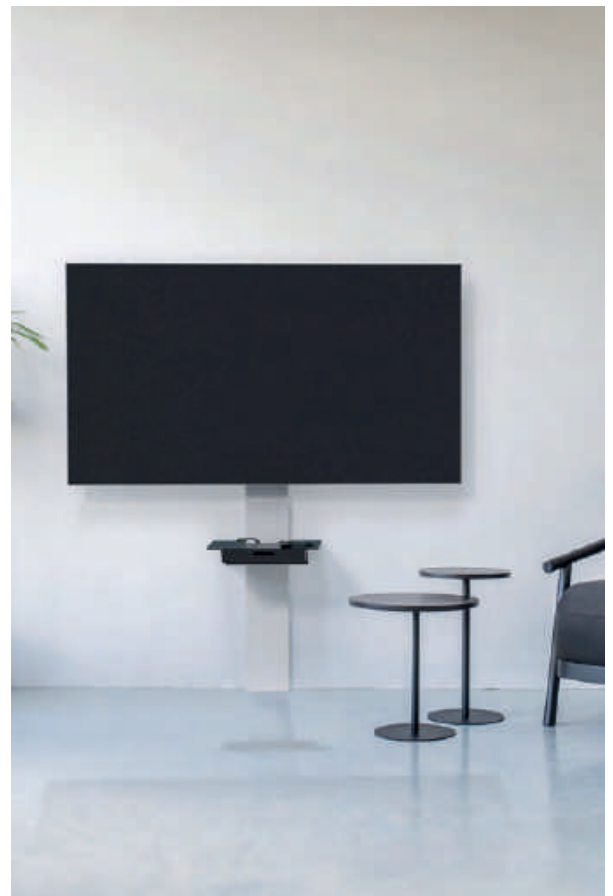

Cover :

Similar to FLAK 1100

Docking shelf :

Screw-in (wall screws included)

For a laptop/Tablet up to 14 inches

Steel, black epoxy paint finish

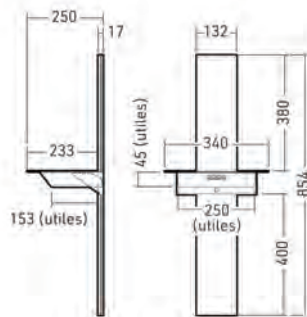

**New** FLAK1100

Ref 035460

EAN 318528 035460 3

CABLE COVER



Cover :

Screw-in (wall screws included)

Extra thin (17 mm)

Compatible with all ERARD mounts

Front panel is clipped on by simple pressure

5 central cable passages

2 side cable passages

Several cable covers can be assembled together

Can be combined with FLAK 800+

PVC Front panel is anti-UV treated

Can be cut to any desired length

Can be painted



## Accessories for ERARD mounts

AV component shelf that can be used either with or without the cable cover.

### AV component shelf

Ref **035490** EAN 318528 035490 0

- Can be used either with or without the cable cover.
- Glass thickness: 5 mm.
- Width: 430 mm.
- Depth: 350 mm.
- Distance from the wall: 5 mm.
- Cable cover: 140 mm.
- Shelf bracket in steel, black epoxy paint finish.
- Shelf secured by a screw.



### Cable cover

Ref **007978** EAN 318528 007978 0

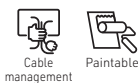

- Length: 1100 mm
- Stick or screw to the wall.
- Can be cut to the required length.
- Can be painted.
- Cable outlets sides, top and bottom
- Several covers may be assembled.
- Sold without cables.

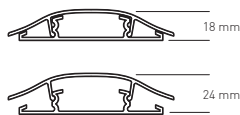
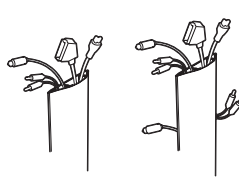



## SOUNDUP, a universal sound bar mount :

Hang your a sound bar on any ERARD TV mount, floor stand or column.

### SOUNDUP

Ref **049589**

EAN 318518 049589 4

UNIVERSAL SOUND BAR MOUNT



7 kg

- Max weight of the sound bar: 7 kg.
- Lengths of the bars: 350 mm and 200 mm.
- 3 mm thick steel, black epoxy paint finish

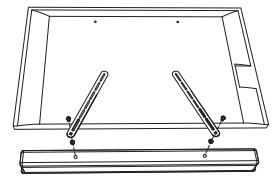
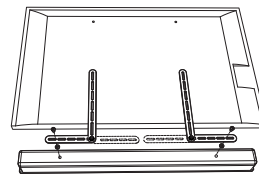

## Adapter kit for screens with curved or irregular rear panel:

100% compatible with ERARD mounts, columns and floor stands.

### KITTVADAPT+

Ref **049592**

EAN 318528 049592 4

ADAPTER KIT FOR SCREENS WITH CURVED OR IRREGULAR REAR PANEL

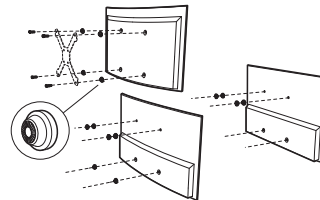
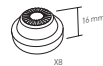

## Adaptor plates

- Designed to fit on brackets with VESA 75, 100 or 200 standards
- Made of steel, zinc-plated or black epoxy paint finish.

### Adaptor plates

FOR SCREENS WITH MOUNTING PATTERN UP TO VESA 200

Ref **002491**

EAN 318528 002491 9



Vesa  
100 > 200

Suitable for screens with VESA 200x100, 200x200, 120x180 on any mount that has a VESA 100 mounting pattern.



### Adaptor plates

FOR SCREENS WITH MOUNTING PATTERN UP TO VESA 200

Ref **045510**

EAN 318528 045510 2



Vesa  
75 > 200

Suitable for screens with VESA 200x200 / 200x100 / 120x180 / GRUNDIG 100x150 / 100x100 on any mount that has a VESA 75 mounting pattern.



### Adaptor plates

FOR SCREENS WITH MOUNTING PATTERN UP TO VESA 400

Ref **045500**

EAN 3 18528 045500 3

Suitable for screens with VESA 200x100, 200x200, 120x180, 200x300, 300x300, 400x400 on any mount that has a VESA 100 and 200 mounting pattern.



# Ceiling mounts for flat panels

## SQUARE

10 YEAR WARRANTY

### Ceiling mounts for screens from 19 to 65"

- Ceiling plate, pole and mounting plate made of steel.
- Epoxy paint finish.
- Adjustable tilt and swivel.
- Locking with special key (provided).
- Adjustable length of the pole.

#### Ceiling mount

Ref **002405** EAN 318528 002405 6

CEILING MOUNT FOR 19" - 43" SCREENS

**M** 19"-43"  
48 - 109 cm

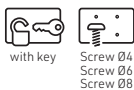
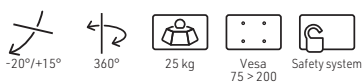

- Continuous tilt.
- Swivel adjustable during the installation.

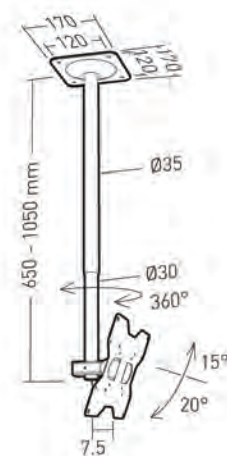

#### Ceiling mount

Ref **049540** EAN 318528 049540 5

CEILING MOUNT FOR 30" - 65" FLAT SCREENS

**L** 30"-65"  
76 - 165 cm

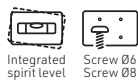

- Continuous tilt and swivel.

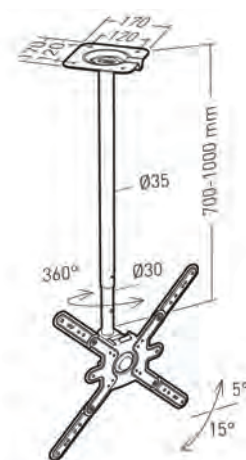

# Ceiling mounts for video projectors

## SQUARE

10 YEAR WARRANTY

### Ceiling mounts for video projectors

- Designed to fix video projectors to the ceiling in an inverted position.
- Image axis can be aligned with the mounting axis.
- Continuously adjustable horizontality and tilt with optional locking.

#### Video projector mount

Ref	<b>002427</b> - Silver	EAN 318528 002427 8
Ref	<b>002428</b> - Black	EAN 318528 002428 5
Ref	<b>002429</b> - White	EAN 318528 002429 2

CEILING MOUNT WITH SWIVELLING PLATE FOR VIDEO PROJECTORS

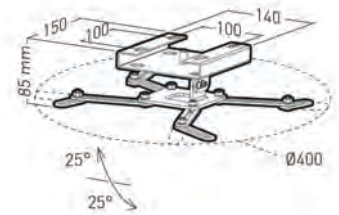
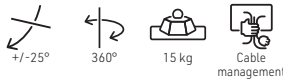

#### Video projector mount

Ref	<b>002431</b> - Silver	EAN 318528 002431 5
-----	------------------------	---------------------

CEILING MOUNT WITH SWIVELLING PLATE AND ADJUSTABLE POLE FOR VIDEO PROJECTORS



- Adjustable extension leads from 54 to 121 cm

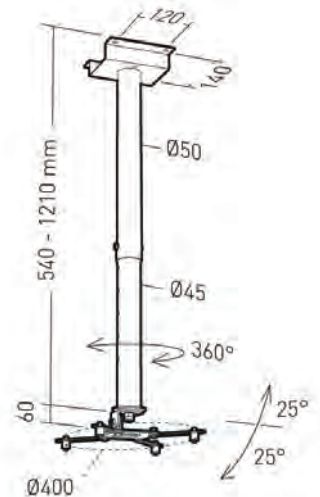

# HOW TO SELECT YOUR COLUMN OR FLOOR STAND FOR FLATSCREENS IN 3 STEPS



**1** What is the screen size ?

**2** Which functions are required ?

**3** Select your column  
...

... consult the product descriptions\* before making your choice

**S** 15"-28"  
38-71 cm

19" 48 cm    20" 51 cm    23" 58 cm    28" 71 cm



FITUP L - 035300 P. 87

19" 20" 23" 28"

*\*The above chart is based on the technical features of the screens currently available on the market and the features specific to ERARD mounts. Details on these technical features can be found in the product pages of the catalogue.*

*Customers are asked to factor in the distance between the screen mounting holes (VESA standard) and the maximum mount weight capacity (shown in kilograms) before making their choice.*

**M** 19"-43"  
48-109 cm

**L** 30"-65"  
76-165 cm

**XL** 40"-85"  
101-215 cm

**XXL** 40"-100"  
101-254 cm

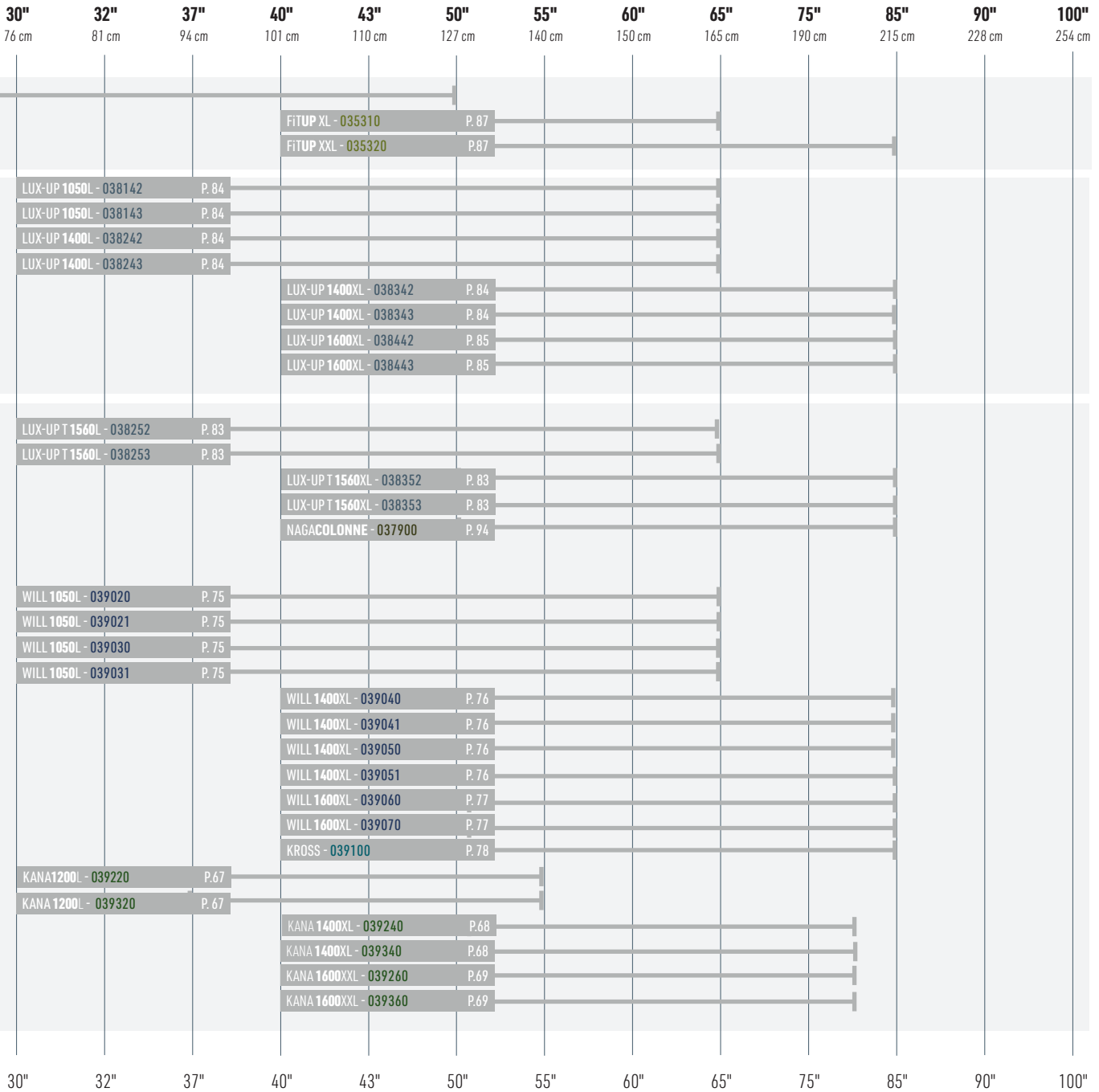



 Screw set and spacers for OLED included

 Max weight of the screen

**IMPORTANT ALL ERARD® MOUNTS INCLUDE:**



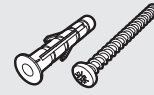

Hardware kit to attach screen to the mount





Hardware kit to attach mount to the wall (solid wall materials)



**FiTUP Range**

					VESA (H x V)																																	
					50x50	75x75	100x100	100x150	150x100	100x200	200x100	200x200	200x300	200x400	300x100	300x200	300x300	300x400	400x100	400x200	400x300	400x400	400x600	500x200	500x300	600x200	600x300	600x400	600x500	800x400	800x500	900x600	1000x600	1200x800				
Ref.	Description	Page																																				
035300	FiTUP L	87		20 Kg																																		
035310	FiTUP XL	87		30 Kg																																		
035320	FiTUP XXL	87		50 Kg																																		

**LUX-UP T & LUX UP Range**

					VESA (H x V)																																	
					50x50	75x75	100x100	100x150	150x100	100x200	200x100	200x200	200x300	200x400	300x100	300x200	300x300	300x400	400x100	400x200	400x300	400x400	400x600	500x200	500x300	600x200	600x300	600x400	600x500	800x400	800x500	900x600	1000x600	1200x800				
Ref.	Description	Page																																				
038252	LUX-UP T 1560L	83	•	30 Kg																																		
038253	LUX-UP T 1560L	83	•	30 Kg																																		
038352	LUX-UP T 1560XL	83	•	50 Kg																																		
038353	LUX-UP T 1560XL	83	•	50 Kg																																		
038142	LUX-UP 1050L	84	•	30 Kg																																		
038143	LUX-UP 1050L	84	•	30 Kg																																		
038242	LUX-UP 1400L	84	•	30 Kg																																		
038243	LUX-UP 1400L	84	•	30 Kg																																		
038342	LUX-UP 1400XL	84	•	50 Kg																																		
038343	LUX-UP 1400XL	84	•	50 Kg																																		
038442	LUX-UP 1600XL	85	•	50 Kg																																		
038443	LUX-UP 1600XL	85	•	50 Kg																																		

**NAGA Range**

					VESA (H x V)																																	
					50x50	75x75	100x100	100x150	150x100	100x200	200x100	200x200	200x300	200x400	300x100	300x200	300x300	300x400	400x100	400x200	400x300	400x400	400x600	500x200	500x300	600x200	600x300	600x400	600x500	800x400	800x500	900x600	1000x600	1200x800				
Ref.	Description	Page																																				
037900	NAGACOLONNE	94	•	50 Kg																																		

\*supplied with shelf





**KANA, and anything becomes possible!**

KANA is the latest addition to the ERARD TV stands. True to its origins, it conveys the values of the brand : stylish design, quality manufacturing, ease of installation and pleasure of use! Supplied with a set of caster wheels (designed by Philippe Starck) and fixed feet, it can be moved around or fixed in one place. Equipped with a rear cable cover, keeping cables out of sight,

and enhancing the focus on the screen. Made of wood or metal, it adapts to all surroundings (home, business) and all styles. Finally, the ability to adjust the height of the screen along the entire length of the column and its compatibility with all types of screen (OLED, QLED, LED, Micro LED, LCD) make it a truly universal product.

Ref 039220 KANA1200L - Metal **New**



Ref 039320 KANA1200L - Wood **New**



Ref 039240 KANA1400XL - Metal **New**



Ref 039340 KANA1400XL - Wood **New**



Ref 039260 KANA1600XXL - Metal **New**



Ref 039360 KANA1600XXL - Wood **New**



# Mobile or fixed TV stand KANA

10 YEAR WARRANTY



Universal TV stand that adapts to every kind of use and to all surroundings. Compatible with all types of screen. Beautiful quality of finish



Cable management within the column (full-height cable passages)



Great amplitude for adjustment of the screen height



Compatible with all screen types (LCD/LED/miniLed/OLED)



Beautiful quality of finish, textured epoxy paint



Supplied with caster wheels and fixed feet



# Mobile or fixed TV stand KANA

10 YEAR WARRANTY

## KANA, mobile or fixed TV stand (with steel column) for screens from 30" to 80"

- Supplied with 4 multidirectional castors and 4 fixed feet
  - Nylon castors of 65 mm diameter, with elastomer tread
  - Polypropylene (PP) fixed feet of 57 mm diameter, height-adjustable
- Column : Steel of 5 mm thickness, ultra-matte polyester paint, colour : cast-iron grey
  - Column : Wood of 52 mm thickness, glued beechwood panel, polyurethane varnish, colour : light oak
  - Base (legs) : Steel of 6 mm thickness, black epoxy paint
  - Contains a set of screws and spacers required to install a screen with a curved or irregular panel (Adapt+ Kit)

### New KANA1200L

Ref **039220 - Metal** EAN 318528 039220 9  
 Ref **039320 - Wood** EAN 318528 039320 6

**30"-55"**  
76 - 140 cm

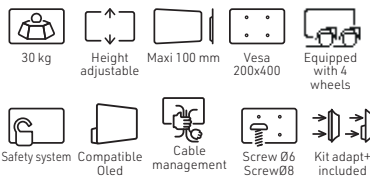

**Logistic dimensions:**  
 Package height : 400 mm  
 Package width : 1190 mm  
 Package length: 160mm  
 Steel package weight: 13.25 kg  
 Wood package weight : 11.86 kg

**All KANA products come with 4 wheels and 4 fixed feet**

### MOBILE OR FIXED TV STAND FOR SCREENS FROM 30" TO 55"

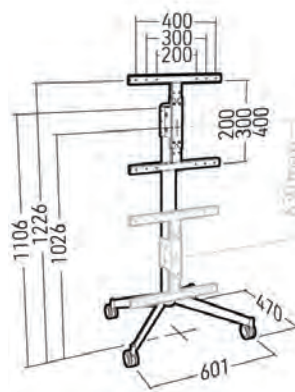

Diagram with wheels

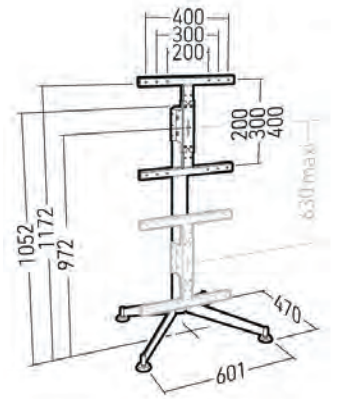

Diagram with feet



# Mobile or fixed TV stand KANA

10 YEAR WARRANTY

68

## New KANA1400XL

Ref **039240** - Metal EAN 318528 039240 7  
 Ref **039340** - Wood EAN 318528 039340 4

MOBILE OR FIXED TV STAND FOR SCREENS FROM 40" TO 80"

**XL** 40"-80"  
101 - 203 cm

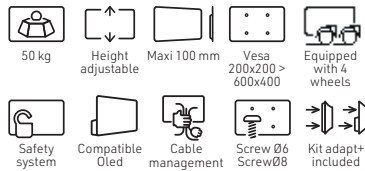

### Logistic dimensions:

Package height : 400 mm  
 Package width: 1190 mm  
 Package length: : 160 mm  
 Weight package Steel : 14.55 kg  
 Wood package weight: 12.45 kg

**All KANA products come with 4 wheels and 4 feet**

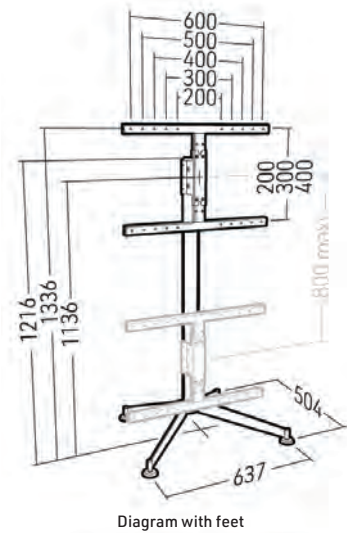
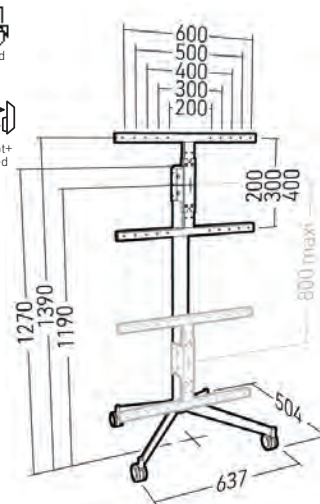

# Mobile and fixed TV stands

## KANA











10 YEAR WARRANTY

**New** KANA1600XXL

Ref **039260** - Métal EAN 318528 039260 5  
 Ref **039360** - Wood EAN 318528 039360 2

MOBILE OR FIXED TV STAND FOR SCREENS FROM 40" TO 80"

**XXL** 40"-80"  
 100 - 203 cm

-  50 kg
-  Height adjustable
-  Maxi 100 mm
-  Vesa 200x200 > 600x400
-  Equipped with 4 wheels
-  Equipped with 2 wheels with brakes
-  Safety system
-  Compatible OLED
-  Cable management
-  Screw Ø6 Screw Ø8
-  Kit Adapt+ included

**Logistic dimensions:**  
 Package height : 400 mm  
 Package width : 1400 mm  
 Package length : 160 mm  
 Steel package weight : 16.05 kg  
 Wood package weight : 13.04 kg

**All KANA products come with 4 wheels and 4 feet**

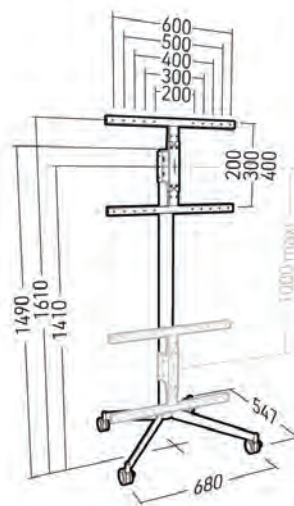

Diagram with wheels

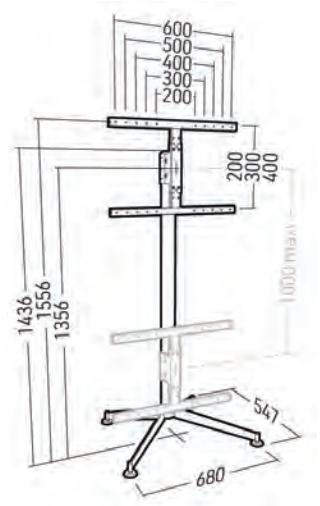

Diagram with feet



Accessories for the KANA range

- KANA Shelf
- KANA Player
- KANA Sound

**New** KANA Shelf

Ref 039290

EAN 318528 039290 2

AV DEVICE SHELF FOR THE KANA TV STAND



5 kg

Shelf to hold AV devices/ remotes  
 Height adjustable.  
 Tempered glass shelf, thickness of 6mm  
 Shelf dimensions : 438 x 240 mm  
 Thickness of fixing block : 56 mm

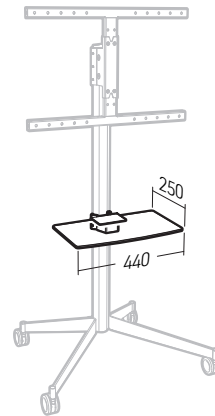

**New** KANA Player

Ref 039291

EAN 318528 039291 9

BRACKET TO HOLD A PERIPHERAL DEVICE (AT REAR OF SCREEN) FOR THE KANA TV STAND



5 kg

Bracket for a peripheral device, positioned on the rear side of the screen on the KANA mounting plate  
 Uses the original screws from the mounting plate  
 Steel of 1.5 mm thickness, black epoxy paint  
 Media player is held in place by 2 elastic cords  
 Reversible right - left : Yes

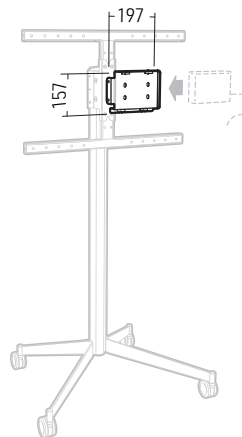

**New** KANA Sound

Ref 039289

EAN 318528 039289 6

UNIVERSAL SOUNDBAR MOUNT FOR THE KANA TV STAND



7 kg

Installation on the column, height of mount can be freely chosen  
 2 possibilities to fix the soundbar : at the rear or on the brackets  
 Max weight of the soundbar : 7kg  
 Depth of the brackets : 83 mm

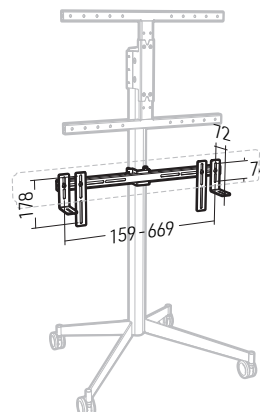







## WILL, and your screen goes mobile !

Designed to allow you to move a screen around the home, your business or in public spaces, WILL ticks all the boxes in terms of ease of movement, manufacturing quality and safety. The cable trunking system and dedicated multi-socket adaptor free up space, helping to showcase your screen.



[www.erard.com/will](http://www.erard.com/will)

Ref 039020 WILL 1050L



Ref 039021 WILL 1050L + Shelf



Ref 039030 WILL 1050L



Ref 039031 WILL 1050L + Shelf



Ref 039040 WILL 1400XL



Ref 039041 WILL 1400XL+ Shelf



Ref 039050 WILL 1400XL



Ref 039051 WILL 1400XL+ Shelf



Ref 039060 WILL 1600XL



Ref 039070 WILL 1600XL





Very easy to move around. Ideal for meeting rooms and public spaces



Dedicated space for a power strip.

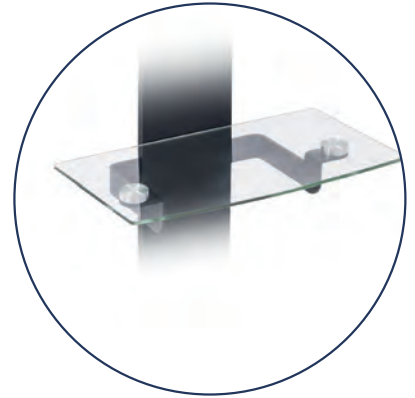

Height adjustable shelf.

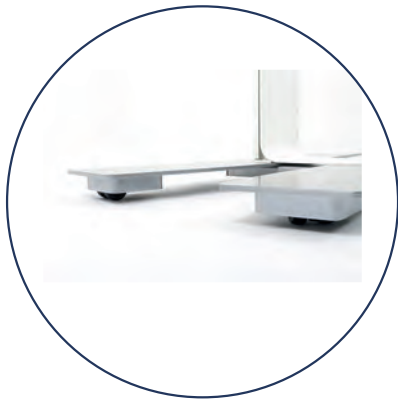

Multidirectional wheels



Cable management in the column.



**WILL 1050L, mobile floor stand for 30"-65" screens**

- Width of the column 150 mm.
- 3 mm steel column, black or white epoxy paint finish.
- 6 mm steel base, silver epoxy paint finish.
- 6 multidirectional wheels, Ø35mm.
- Screen height adjustable by 125 mm.
- Cable management inside the column.
- Dedicated space for a power strip in the column.
- Available with or without a shelf.
- Shelf height adjustment +/- 75 mm.

**WILL 1050L**

<b>Without shelf</b>	<b>Ref</b>	<b>039030 - Black</b>	EAN 318528 039030 4
<b>With shelf</b>	<b>Ref</b>	<b>039031 - Black</b>	EAN 318528 039031 1
<b>Without shelf</b>	<b>Ref</b>	<b>039020 - White</b>	EAN 318528 039020 5
<b>With shelf</b>	<b>Ref</b>	<b>039021 - White</b>	EAN 318528 039021 2

MOBILE FLOOR STAND FOR 30"-65" SCREENS

**L** 30"-65"  
76 - 165 cm

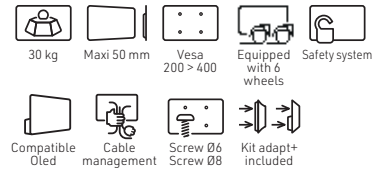

**Logistic dimensions:**

Package height : 165 mm  
Package width : 370 mm  
Package length : 1110 mm  
Package weight : 28 kg

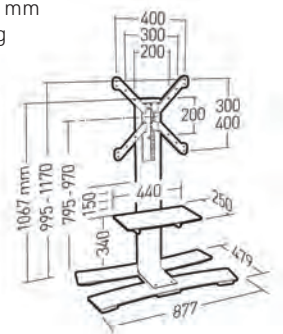

**WILL 1400XL, mobile floor stand for 40"-85" screens**

- Width of the column 150 mm.
- 4 mm steel column, black or white epoxy paint finish.
- 6 mm steel base, silver epoxy paint finish.
- 6 multidirectional wheels, Ø35mm.
- Screen height adjustable by 125 mm.
- Cable management inside the column.
- Dedicated space for a power strip in the column.
- Available with or without a shelf.
- Shelf height adjustment +/-100 mm.
- Shelf height adjustable by 125 mm.
- Possibility to mount the screen in portrait or landscape (up to VESA 400x400)

**WILL 1400XL**



<b>Without shelf</b>	<b>Ref</b>	<b>039050 - Black</b>	EAN 318528 039050 2
<b>With shelf</b>	<b>Ref</b>	<b>039051 - Black</b>	EAN 318528 039051 9
<b>Without shelf</b>	<b>Ref</b>	<b>039040 - White</b>	EAN 318528 039040 3
<b>With shelf</b>	<b>Ref</b>	<b>039041 - White</b>	EAN 318528 039041 0

MOBILE FLOOR STAND FOR 40"-85" SCREENS

**XL** 40"-85"  
101 - 215 cm

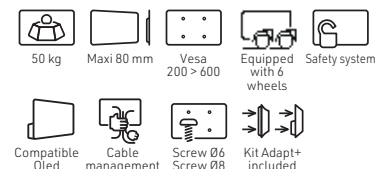

**Logistic dimensions:**

Package height : 170 mm  
 Package width : 364 mm  
 Package length : 1434 mm  
 Package weight : 38.50 kg

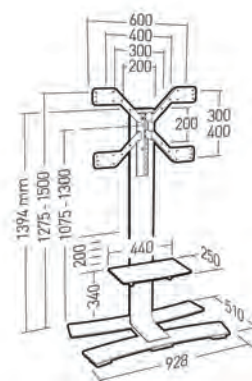

**WILL SHELF**

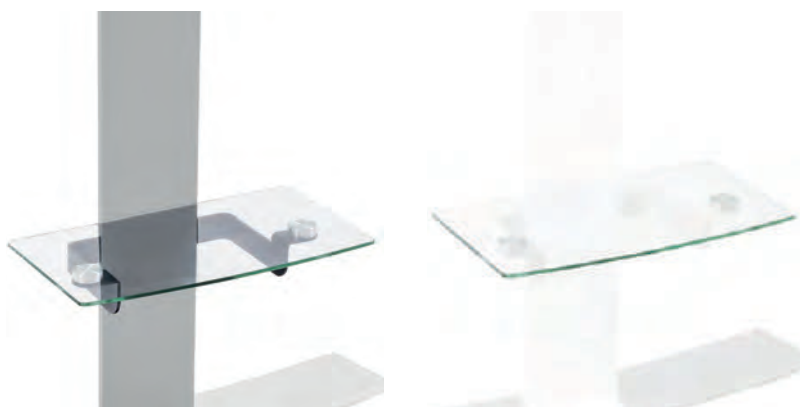

<b>Ref</b>	<b>039080 - White</b>	EAN 318528 039080 9
<b>Ref</b>	<b>039090 - Black</b>	EAN 318528 039090 8

AV DEVICE SHELF FOR WILL FLOORSTAND



5 kg

- Additional shelf for a peripheral.
- Height adjustable.
- Tempered 6 mm glass shelf.
- Dimensions: 440 X 250 mm.
- Total thickness: 72 mm.

## WILL 1600XL, mobile floor stand for 40"-85" screens

Width of the column 150 mm.

- 4 mm steel column, black or white epoxy paint finish.
- 6 mm steel base, silver epoxy paint finish.
- 10 multidirectional wheels, Ø35mm.
- Screen height adjustment on 200 mm.
- Cable management inside the column..

- Dedicated space for a power strip in the column.
- Shelf available as an option (p76)
- Possibility to mount the screen in portrait or landscape

## WILL 1600XL

Ref	<b>039070 - Black</b>	EAN 318528 039070 0
Ref	<b>039060 - White</b>	EAN 318528 039060 1

MOBILE FLOOR STAND FOR 40"-85" SCREENS

**XL** 40"-85"  
101 - 215 cm

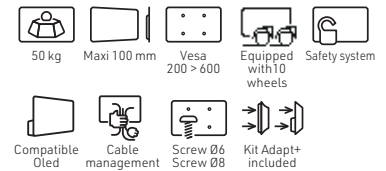

### Logistic dimensions:

Package height : 180 mm  
Package width : 650 mm  
Package length : 1630 mm  
Package weight : 47 kg

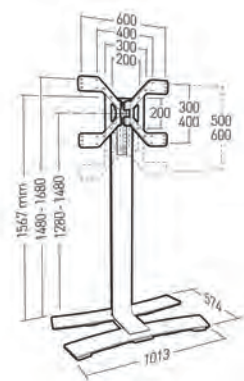

## MEDIA BOX MOUNT

Ref **039101** EAN 3 18528 039101 1

Compatible with  
WILL 1400 XL  
columns  
and WILL 1600 XL  
Colour : black

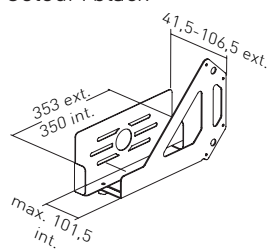

## CAMERA SHELF (REVERSIBLE)

Ref **039095** EAN 3 18528 039095 3

Compatible with all  
the WILL columns  
For camera installation  
above or below the screen  
Colour : black

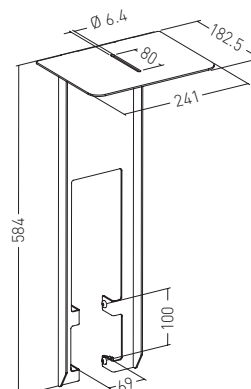

# Floor stands

## KROSS

10 YEAR WARRANTY

78

### KROSS, mobile floor stand for very large screens

- Perfect for narrow passageways.
- The screen can be positioned anywhere along the column.
- 10 mm steel base, epoxy silver paint finish.
- Anodized aluminium column.
- 10 Ø75 mm multi-directional caster wheels.
- Cable management in the column.
- Possibility to add an AV device shelf, a camera shelf and codec mounts (sold separately).



### KROSS

Ref **039100** EAN 318528 039100 4

MOBILE FLOOR STAND FOR 40"-85" SCREENS

**XL** 40"-85"  
101 - 215 cm

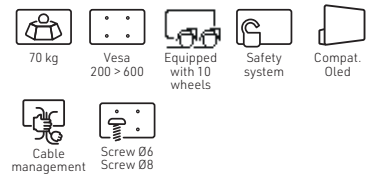

#### Logistic dimensions:

Package height : 180 mm  
 Package width : 650 mm  
 Package length : 1630 mm  
 Package weight 47 kg

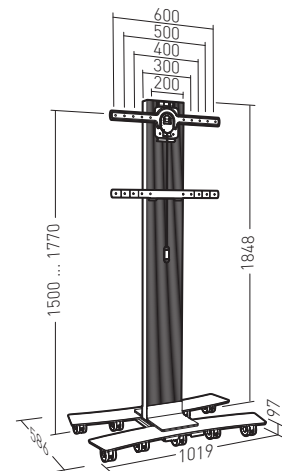

### KROSS SHELF



Ref **039104** EAN 318528 039104 2

AV DEVICE SHELF



### KROSS CAM



Ref **039108** EAN 318528 039108 0

CAMERA SHELF



### KROSS BOX



Ref **039116** EAN 318528 039116 5

ADJUSTABLE CODEC HOLDER BOX









**LUX UP and LUX-UP T: show off your screen!**

Whether it is for your home or your business, in your living room or in the classroom, LUX UP is a great way of showcasing your TV. A genuine alternative to wall mounts (the screen is suspended, but the wall remains intact), with a stylish design and a stunning finish, LUX UP is a popular choice among both private customers and professionals.

LUX UP T is an upgrade on LUX UP. With a rectilinear base that allows you to get as close as possible to the wall, a reversible head that gives you significant scope for adjusting the height of the screen and a highly flexible screen tilt/swivel system to prevent glare, you can install your television in any room, no matter the style, with unrivalled levels of performance.



[www.erard.com/luxupt](http://www.erard.com/luxupt)

Ref 038142 LUX-UP 1050L



Ref 038143 LUX-UP 1050L



Ref 038242 LUX-UP 1400L



Ref 038243 LUX-UP 1400L



Ref 038342 LUX-UP 1400XL



Ref 038343 LUX-UP 1400XL



Ref 038443 LUX-UP 1600XL



Ref 038442 LUX-UP 1600XL



Ref 038253 LUX-UP T 1560L



Ref 038252 LUX-UP T 1560L



Ref 038353 LUX-UP T 1560XL



Ref 038352 LUX-UP T 1560XL



## LUX-UP, swivel floor stands for 30"-65" screens

- Steel base ; black or white epoxy paint finish
- Mast diameter 60 mm ; chrome epoxy paint finish.
- Incorporated cable management in the pole.
- Screen swivel +/- 20°.
- Screen height adjustment +/- 50 mm.

**+** Very slim base and very stable. Ideal for trade fairs and exhibitions

### LUX-UP 1050L

Ref **038142 - Black** EAN 318528 038142 5  
 Ref **038143 - White** EAN 318528 038143 2

**L** 30"-65"  
76 - 165 cm

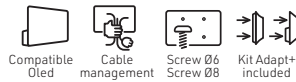

**Logistic dimensions:**  
 Package height : 100 mm  
 Package width : 540 mm  
 Package length : 1030 mm  
 Package weight : 19.4 kg



### UNIVERSAL FLOOR STAND FOR 30"-65" SCREENS

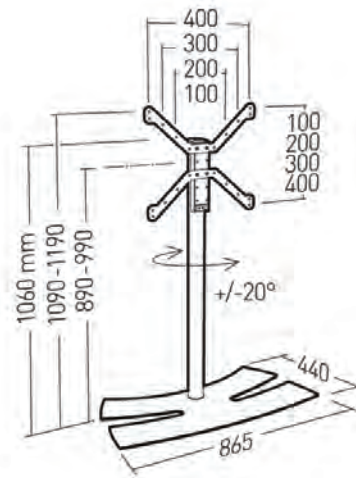

Incorporated cable management in the pole.

### LUX-UP 1400L

Ref **038242 - Black** EAN 318528 038242 2  
 Ref **038243 - White** EAN 318528 038243 9

**L** 30"-65"  
76 - 165 cm

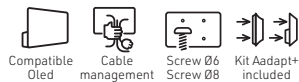

**Logistic dimensions:**  
 Package height : 100 mm  
 Package width : 660 mm  
 Package length : 1385 mm  
 Package weight : 24 kg



### UNIVERSAL FLOOR STAND FOR 30"-65" SCREENS

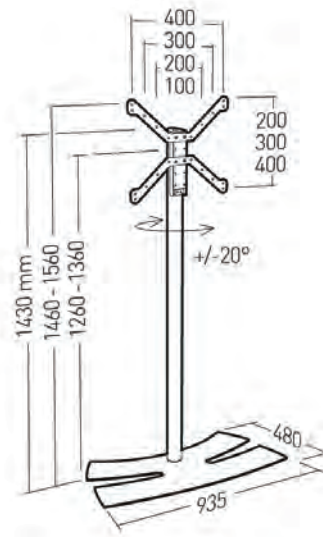

Shelf for a peripheral (sold as an option).

## LUX-UP XL, floor stands for 40-85" screens

- 8 mm steel base ; black or white epoxy paint finish
- Mast diameter 60 mm ; chrome epoxy paint.
- Incorporated cable management in the pole.
- Possibility to install the screen in portrait or landscape mode.
- Screen height adjustment +/- 50 mm.

### LUX-UP 1400XL



Ref **038342 - Black** EAN 318528 038342 9  
Ref **038343 - White** EAN 318528 038343 6

**XL** 40"-85"  
101 - 215 cm

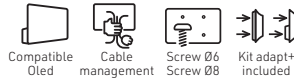

**Logistic dimensions:**  
Package height : 100 mm  
Package width : 660 mm  
Package length : 1385 mm  
Poids du colis : 29 kg

### UNIVERSAL FLOOR STAND FOR 40-85" SCREENS

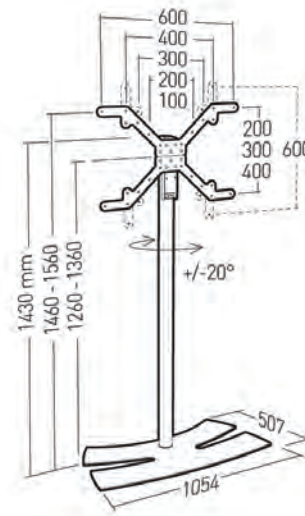

### LUX-UP 1600XL

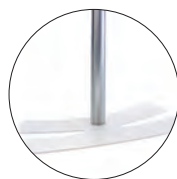

Ref **038442 - Black** EAN 318528 038442 6  
Ref **038443 - White** EAN 318528 038443 3

**XL** 40"-85"  
101 - 215 cm

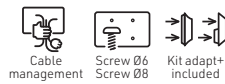
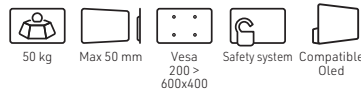

**Logistic dimensions:**  
Package height : 90 mm  
Package width : 775 mm  
Package length : 1720 mm  
Poids du colis : 46.40 kg

### UNIVERSAL FLOOR STAND FOR 40-85" SCREENS

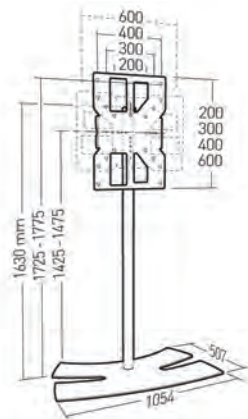
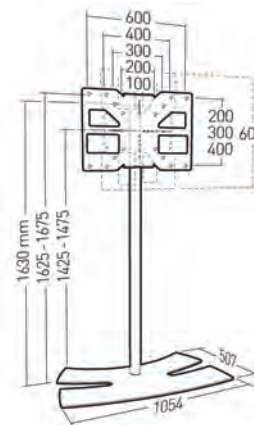

# Fixed floor stands LUX-UP T

10 YEAR WARRANTY



BVCert. 6164725

## LUX-UP T, tilt and swivel floor stands for 30"-85" screens

- Steel base; black or white epoxy paint finish
- Mast diameter 60 mm ; chrome epoxy paint.
- Incorporated cable management in the pole.
- Screen swivel +/-20° and tilt +/-10°.
- Screen height adjustment on 475 mm.
- Tilting, swivelling and reversible head.
- New design of the base to be placed as close as possible to the wall.
- Possibility to install the screen in portrait mode (option).

**+** Screen tilt mechanism to quickly minimize any screen glare. Perfect for window display.

### LUX-UP T 1560L

Ref **038252 - Black** EAN 318528 038252 1 UNIVERSAL FLOOR STAND, TILT AND SWIVEL FOR 30"-65" SCREENS  
 Ref **038253 - White** EAN 318528 038253 8

**L** 30"-65"  
76 - 165 cm

+/-10°   
 +/-20°   
 30 kg   
 Vesa 100 > 400   
 Safety system

Compatible OLED   
 Cable management   
 Screw Ø6 Screw Ø8   
 Kit Adapt+ included

**Logistic dimensions:**  
 Package height : 100 mm  
 Package width : 660 mm  
 Package length : 1385 mm  
 Package weight : 29.5 kg

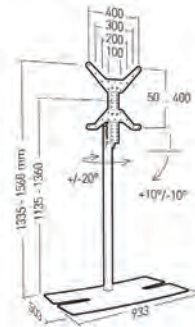

Large screen height adjustment capacity.



Reversible head.

### LUX-UP T 1560XL

Ref **038352 - Black** EAN 318528 038352 8 UNIVERSAL FLOOR STAND, TILT AND SWIVEL  
 Ref **038353 - White** EAN 318528 038353 5 FOR 40"-85" SCREENS

**XL** 40"-85"  
101 - 215 cm

+/-10°   
 +/-20°   
 50 kg   
 Vesa 100 > 600   
 Safety system

Compatible OLED   
 Cable management   
 Screw Ø6 Screw Ø8   
 Kit Adapt+ included

**Logistic dimensions:**  
 Package height : 100 mm  
 Package width : 660 mm  
 Package length : 1385 mm  
 Package weight : 32.5 kg

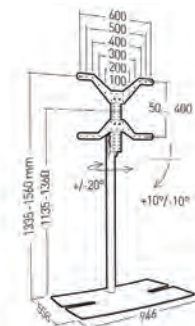

Adjustable tilt (+/-10°) to prevent glare on the screen.



New design of the base, to be placed as close as possible to the wall.

## Accessories for the LUX UP range

Shelves for peripheral devices  
Peripheral holders

### LUXUP SHELF

Ref **038400** EAN 3 18528 038400 6

#### SHELF FOR AV DEVICE



5 kg

Additional shelf for a peripheral  
Positioned to the right of the pole  
Fixed on the rear side of the pole with 2 screws  
6 mm tempered glass  
Max weight 5 kg  
Useful shelf space: 420 X 240 mm

#### Logistic dimensions:

Package height : 50 mm  
Package width : 370 mm  
Package length : 470 mm  
Package weight : 2.64 kg



### BOX UP

Ref **038401** EAN 3 18528 038401 3

#### PERIPHERAL HOLDER FOR THE REAR OF THE SCREEN

Peripheral holder positioned on the rear side of the column (Lux-Up, Lux-Up T and WILL).  
Installation with two screws.  
Steel structure, black epoxy paint finish.  
Peripheral is held in place thanks to 3 elastic cords.  
Reversible right / left.  
Dimensions (height x width x thickness):  
290 x 288 x 31 mm.

#### Logistic dimensions:

Package height : 55 mm  
Package width : 305 mm  
Package length : 304 mm  
Package weight : 1.41 kg

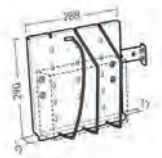



## Universal table top TV mounts for 20"-90" screens

- Replaces the original base
- Allows a sound bar to be placed under the screen
- Steel thickness of 5 mm (FiTUP L, FiTUP XL) and 6 mm (FiTUP XXL).
- Silver and black epoxy paint finish
- Height adjustable spacing holes of 25mm



Allows a large screen to be installed in a limited floor space.



[www.erard.com/fit-up](http://www.erard.com/fit-up)

### FiTUP L

Ref **035300**

EAN 318528 035300 2

UNIVERSAL TABLE TOP TV MOUNT FOR 20"-50" SCREENS

**L** 20"-50"  
51 - 127 cm

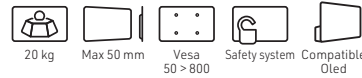

**Logistic dimensions:**  
Package height : 100 mm  
Package width : 260 mm  
Package length : 460 mm  
Package weight : 4,5 kg

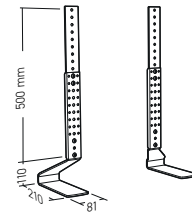

### FiTUP XL

Ref **035310**

EAN 318528 035310 1

UNIVERSAL TABLE TOP TV MOUNT FOR 40"-65" SCREENS

**XL** 40"-65"  
101 - 165 cm

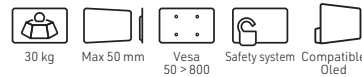

**Logistic dimensions:**  
Package height : 120 mm  
Package width : 330 mm  
Package length : 600 mm  
Package weight : 8,23 kg

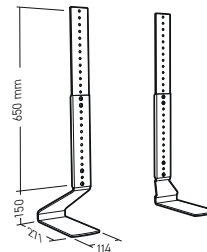

New

### FiTUP XXL

Ref **035320**

EAN 318528 035320 0

UNIVERSAL TABLE TOP TV MOUNT FOR 40"-90" SCREENS

**XXL** 40"-90"  
101 - 228 cm

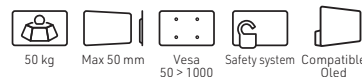

**Logistic dimensions:**  
Package height : 100 mm  
Package width : 440 mm  
Package length : 800 mm  
Package weight : 13.3 kg

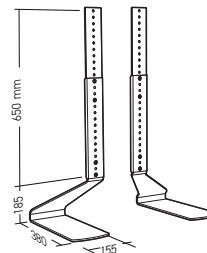





**NAGA, built to serve!**

NAGA is a multi-purpose TV unit designed to please lovers of the small screen, with plenty of room for home cinema speakers, a door that allow infrared signals from remote controls to pass through, height adjustable legs, an optional column, and much more. NAGA also takes into account

the use of new technology, with an innovative dual charging solution (USB and induction) in a specific compartment dedicated to cables and multi-socket adapters.



[www.erard.com/naga](http://www.erard.com/naga)

Ref 037410 NAGA 1400 HATCH



Ref 037400 NAGA 1400 HATCH



Ref 037411 NAGA 1400 Qi + USB



Ref 037401 NAGA 1400 Qi + USB



Ref 037610 NAGA 1600 HATCH



Ref 037600 NAGA 1600 HATCH



Ref 037611 NAGA 1600 Qi + USB



Ref 037601 NAGA 1600 Qi + USB



Ref 037641 NAGA 1600 S Qi + USB **New**



Ref 037651 NAGA 1600 S Qi + USB **New**



Ref 037011 NAGA 2000 Qi + USB **New**



Ref 037001 NAGA 2000 Qi + USB **New**



Ref 037900 NAGA COLUMN XL



# UX Design furniture NAGA

10 YEAR WARRANTY

90



Height adjustable legs  
386 or 450 mm.

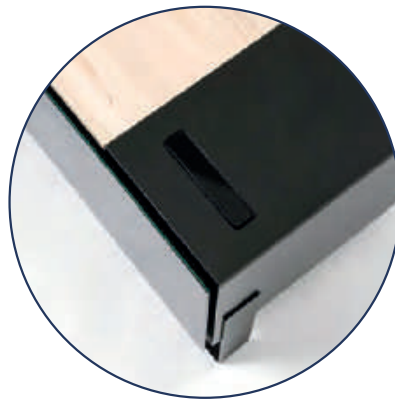

Qi induction charging station  
for mobile phones



Charger 4 USB (depending on model)  
Input: 100-240 VAC - (50/60 Hz)  
Output 1~4 USB A: 5V / 2.4A (Smart IC)



Gas springs and concealed hinges.



Cable management on the top of the  
cabinet.



Wide openings at rear for equipment  
ventilation.



Technical compartment for power  
cable management.

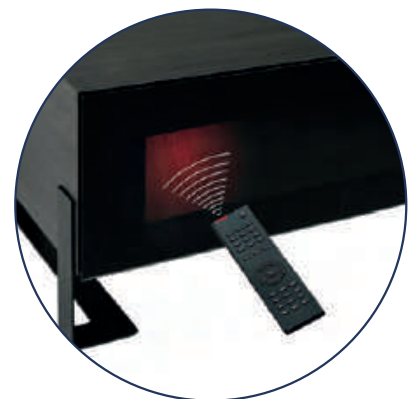

Screen-printed remote-friendly door.

## NAGA 1400

- 3 compartments.
- Usable volume of the 3 compartments:  
Width 650 x Height 240 x Depth 440 mm,  
Width 439 x Height 240 x Depth 440 mm,  
Width 190 x Height 240 x Depth 440 mm.

- 2 versions : with or without chargers ( 4 x USB ports and 1 x Qi induction charger
- 2 colours : Nordic and Carbon.
- Possibility to add a NAGA column (sold separately).

## NAGA 1400 HATCH

Ref **037400** - Nordic EAN 318528 037400 7  
Ref **037410** - Carbon EAN 318528 037410 6

NAGA 1400 + HATCH

**L** 30"-65"  
76 - 165 cm



**Logistic dimensions:**  
Package height : 145 mm  
Package width : 545 mm  
Package length : 1480 mm  
Package weight : 45.5 kg

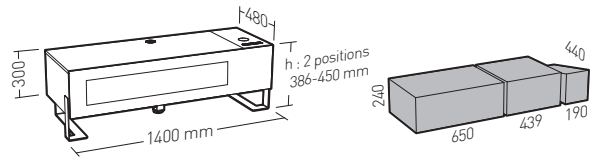

## NAGA 1400 Qi + USB

Ref **037401** - Nordic EAN 318528 037401 4  
Ref **037411** - Carbon EAN 318528 037411 3

NAGA 1400 + HATCH + QI + 4 USB CHARGER

**L** 30"-65"  
76 - 165 cm



**Logistic dimensions:**  
Package height : 145 mm  
Package width : 545 mm  
Package length : 1480 mm  
Package weight : 45.9 kg

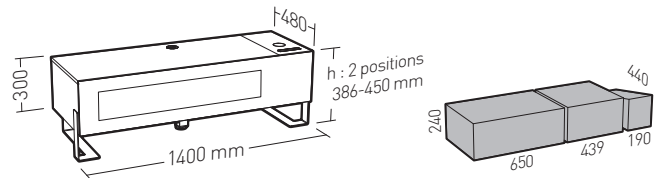

# NAGA

10 YEAR WARRANTY

## NAGA 1600

- 3 compartments.
- Usable volume of the 3 compartments:  
Width 750 x Height 240 x Depth 440 mm,  
Width 539 x Height 240 x Depth 440 mm,  
Width 190 x Height 240 x Depth 440 mm.
- 2 versions : with or without chargers (4 x USB ports and 1 x Qi induction charger).
- 2 colours : Nordic and Carbon.
- Possibility to add a NAGA column (sold separately).

[www.erard.com/naga](http://www.erard.com/naga)

## NAGA 1600 HATCH

Ref **037600** - Nordic EAN 318528 037600 1 NAGA 1600 + HATCH  
Ref **037610** - Carbon EAN 318528 037610 0

**XL** 40"-85"  
101 - 215 cm



50 kg



Cable management

**Logistic dimensions:**  
Package height : 145 mm  
Package width : 545 mm  
Package length : 1680 mm  
Package weight : 51 kg

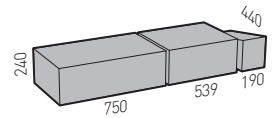
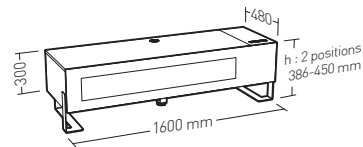

## NAGA 1600 Qi + USB

Ref **037601** - Nordic EAN 318528 037601 8 NAGA 1600 + HATCH + Qi + 4 USB CHARGER  
Ref **037611** - Carbon EAN 318528 037611 7

**XL** 40"-85"  
101 - 215 cm



50 kg



Cable management

**Logistic dimensions:**  
Package height : 145 mm  
Package width : 545 mm  
Package length : 1680 mm  
Package weight : 51.50 kg

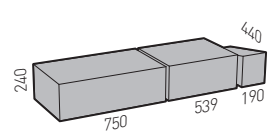
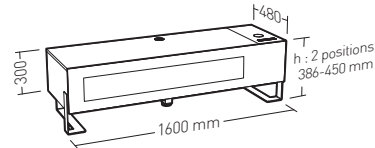

## NAGA 1600 S

- Designed to accommodate a soundbar
- Front flap with acoustic fabric, allowing sound to pass through
- Usable volume of the 3 compartments:  
Width 750 x Height 240 x Depth 440 mm,  
Width 539 x Height 240 x Depth 440 mm,  
Width 190 x Height 240 x Depth 440 mm.

- 4 x USB ports and 1 x Qi induction charger
- 2 colours available : Nordic and Carbon.
- Optional installation of a NAGA column (sold separately).

### New NAGA 1600 S Qi + USB

Ref	037641 - Nordic	EAN 318528 03764 1
Ref	037651 - Carbon	EAN 318528 03765 1

NAGA 1600 S + FABRIC FRONT + HATCH + Qi + 4 USB CHARGER

**XL** 40"-85"  
101 - 21 cm



50 kg



Cable management

**Logistic dimensions:**  
Package height : 145 mm  
Package width : 545 mm  
Package length : 1680 mm  
Package weight : 51.5 kg

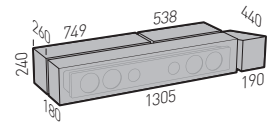
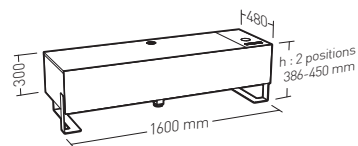

\* Soundbar not included. Soundbar not included.



NAGA 2000

- 4 compartments.
- Usable volume of the 4 compartments:  
Width 550 x Height 240 x Depth 440 mm,  
Width 570 x Height 240 x Depth 440 mm,  
Width 550 x Height 240 x Depth 440 mm,  
Width 190 x Height 240 x Depth 440 mm.

- 2 colours : Nordic and Carbon.
- Possibility to add a NAGA column (as option).

**New** NAGA 2000 Qi + USB

Ref **037001 - Nordic** EAN 318528 037001 6 NAGA 2000 + HATCH + Qi + 4 USB CHARGER  
 Ref **037011 - Carbon** EAN 318528 037011 5

**XXL** 40"-100"  
101 - 228 cm



Logistic dimensions:  
 Package height : 155 mm  
 Package width : 545 mm  
 Package length : 2080 mm  
 Package weight : 53 kg

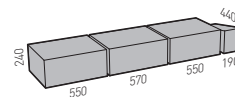
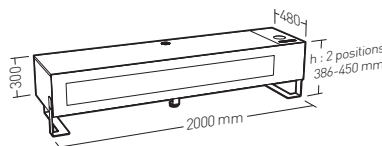

NAGA COLUMN

- Made of steel, black epoxy paint finish
- Compatible with all NAGA models
- Reversible head for greater height capacity

NAGA **COLUMN XL**

Ref **037900** EAN 318528 037900 2 NAGA COLUMN XL 40"-85"

**XL** 40"-85"  
101 - 215 cm

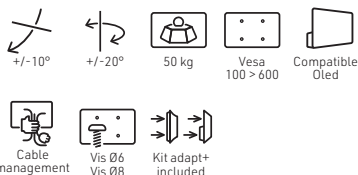

- Screen height adjustable by 620 mm.
- Cable management in the pole.
- Tilt and swivel TV mount.

Logistic dimensions:  
 Package height : 100 mm  
 Package width : 100 mm  
 Package length : 940 mm  
 Package weight : 7 kg

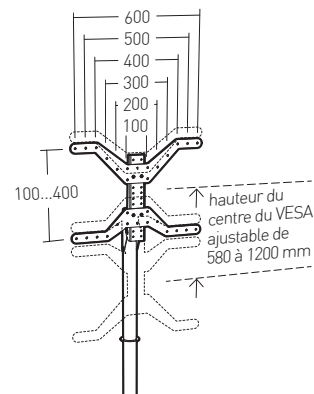





EXAMPLE SHOWING A 66 x 100 CM CONFIGURATION FOR AN ERARD® 66 STRUCTURE

- 19 mm wood panels.
- Steel mounting structure and accessories.

## ERARD® 66 Option Structure



Ref. **002800** EAN 318528 002800 9

THE 66 CM STRUCTURE ALLOWS POSITIONING OF THE 66 X 100 CM DISPLAY PANEL

## 66 X 100 cm Assortment - CLIFF

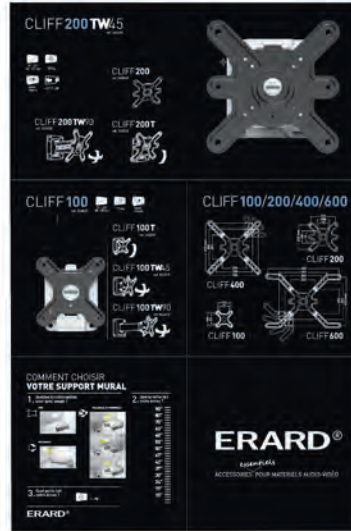

Ref. **002745** EAN 318528 002745 3

FOR WALL MOUNTING  
OR ON STRUCTURE ERARD® 66

- 4 WALL MOUNT DISPLAY MODULES
- 2 DEMO PRODUCTS
- 1 HELP MODULE

- 19 mm wood panels.
- Steel mounting structure and accessories.

## 66 X 100 cm Assortment - FiXiT - EXO

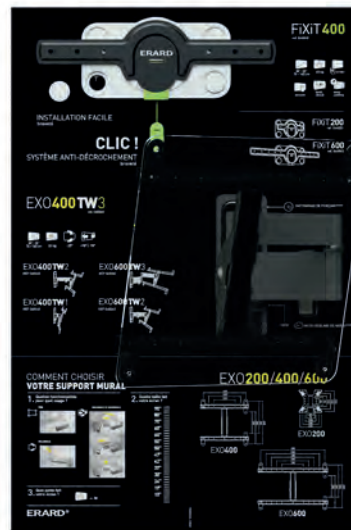

Ref. **002857** EAN 318528 002857 3

FOR WALL MOUNTING  
OR ON STRUCTURE ERARD® 66

- 3 WALL MOUNT DISPLAY MODULES
- 2 DEMO PRODUCTS
- 1 HELP MODULE

- 19 mm wood panels.
- Steel mounting structure and accessories.

## 66 X 100 cm Assortment CLIFF - EXO

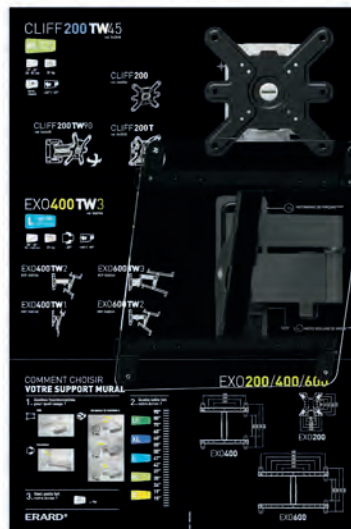

Ref. **002858** EAN 318528 002858 0

FOR WALL MOUNTING  
OR ON STRUCTURE ERARD® 66

- 3 WALL MOUNT DISPLAY MODULES
- 2 DEMO PRODUCTS
- 1 HELP MODULE

- 19 mm wood panels.
- Steel mounting structure and accessories.



133 x 33 cm Assortment - FiXiT



Ref. 002732 EAN 318528 002732 3

- FOR WALL MOUNTING OR FOR LOW SHELVING
- 19 mm wood panels.
  - Steel mounting structure and accessories.

133 x 33 cm Assortment - CLIFF

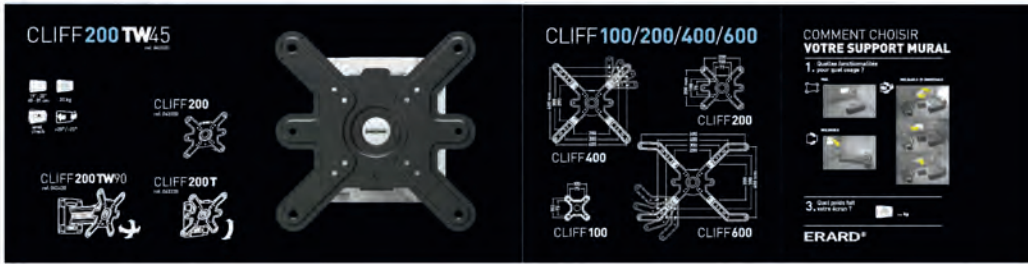

Ref. 002733 EAN 318528 002733 0

- FOR WALL MOUNTING OR FOR LOW SHELVING
- 19 mm wood panels.
  - Steel mounting structure and accessories.

133 x 33 cm Assortment - EXO 400/600

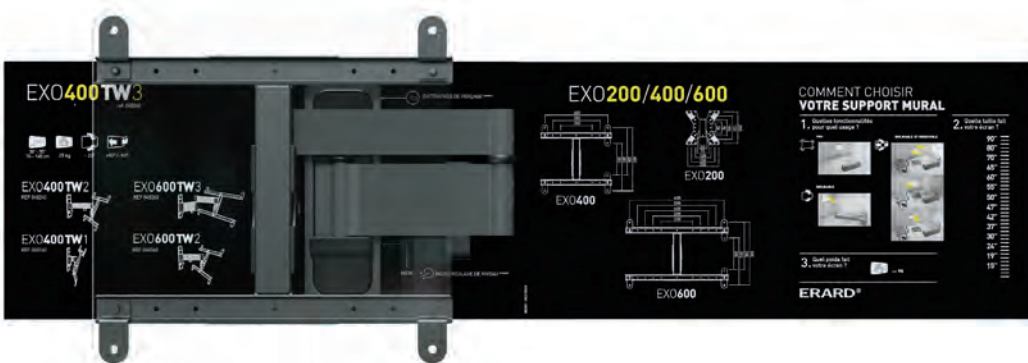

Ref. 002859 EAN 318528 002859 7

- FOR WALL MOUNTING OR FOR LOW SHELVING
- 19 mm wood panels.
  - Steel mounting structure and accessories.



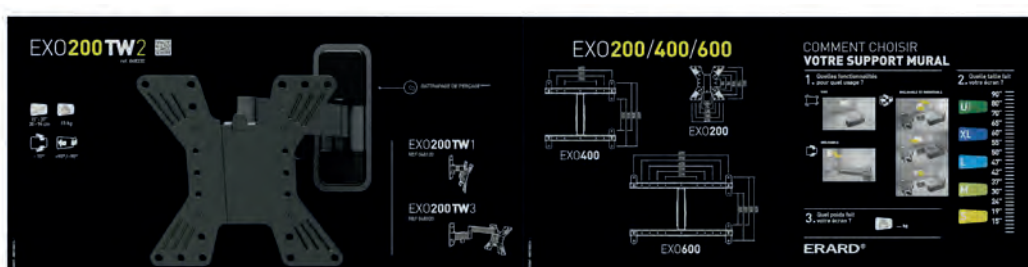



































































133 x 33 cm Assortment - EXO 200



































































Ref. 002860 EAN 318528 002860 3

- FOR WALL MOUNTING OR FOR LOW SHELVING
- 19 mm wood panels.
  - Steel mounting structure and accessories.

## INDEX

	002405	58		011108	18		037600	95		038401	85
	002407	27		011109	21		037601	95		038442	83
	002423	24		011112	20		037610	92		038443	83
	002427	59		011115	19		037611	92		039020	75
	002428	59		011200	16		037641	93		039021	75
	002429	59		011205	17		037651	93		039030	75
	002430	24		035300	87		037900	94		039031	75
	002431	59		035310	87		038142	82		039040	76
	002453	24		035320	87		038143	82		039041	76
	002491	57		035450	55		038242	82		039050	76
	002530	27		035460	55		038243	82		039051	76
	002531	27		035490	56		038252	84		039060	77
	002532	26		037001	94		038253	84		039070	77
	002580	24		037011	94		038342	83		039080	76
	007978	56		037400	91		038343	83		039090	77
	011100	18		037401	91		038352	84		039095	78
	011102	18		037410	91		038353	84		039100	78
	011105	19		037411	91		038400	85		039101	79

	039104	78		043240	32		044661	41		048345	52
	039108	78		043260	33		044690	41		048360	51
	039116	78		043310	30		045004	25		048380	50
	039220	67		043320	31		045007	25		048390	51
	039240	68		043340	32		045040	26		048440	47
	039260	69		043410	30		045201	25		048460	47
	039289	70		043420	31		045500	57		048461	47
	039290	70		043440	32		045510	57		049540	58
	039291	70		043490	33		044762	41		049589	57
	039320	67		044020	36		044767	41		049592	57
	039340	68		044040	36		048120	49			
	039360	69		044042	37		048140	50			
	043010	30		044060	36		048220	49			
	043020	31		044062	37		048240	50			
	043040	32		044240	38		048260	51			
	043060	33		044440	38		048265	45			
	043210	30		044640	41		048320	49			
	043220	31		044660	41		048340	50			



## Customer service

### PROFESSIONALS

Monday - Friday, 8.30 am - 6 pm

Phone

**+33 (0)4 72 46 16 26**

Fax

**+33 (0)4 72 46 16 22**

E-mail

**infos@erard.fr**

Post

**ERARD - ZI de Chavanoz  
4, route de la plaine  
38230 CHAVANOZ - FRANCE**

### INDIVIDUALS

Monday - Friday, 8.30 am - 6 pm

Answers to your questions on our products, requests for documentation, information on the nearest distributor, technical pre-diagnosis etc...

By phone

**+33 (0) 472 46 16 26**

**ERARD®**

A corporation with capital of 1 681 791,25 €  
Trade register of Vienne B 403 591 415  
VAT N° : FR 81 403 591 415



## Find our other product ranges

**MOUNTS AND HOUSINGS FOR PROFESSIONALS**

**CONNECTION SYSTEMS CATALOGUE**

**HARDWARE FOR ANTENNAS AND SATELLITE DISHES**

**CONNECTION SYSTEMS FOR PROFESSIONALS**

at [www.erard.com](http://www.erard.com)

